

HTMH

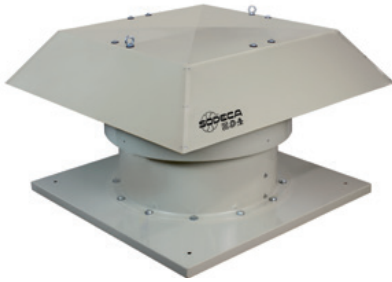

Multifunktionale Dachventilatoren für große Volumenströme



Multifunktionale Dachventilatoren in robuster Ausführung zum Abzug großer Volumenströme

Ventilator:

- Sockel aus verzinktem und lackiertem Stahlblech.
- Verstellbare Laufräder aus Aluminiumguss.
- Berührungsschutzgitter gemäß Norm UNE-EN ISO 12499.
- Schutzhaube aus verzinktem und lackiertem Stahlblech mit natürlichem Luftauslass.

Motor:

- Motoren der Effizienzklasse IE3 für Leistungen $\geq 0,75$ kW, außer Einphasenmotoren, Motoren mit 2 Drehzahlstufen und 8 Polen.
- Motoren der Effizienzklasse F, mit Kugellager, Schutzart IP55, 1 oder 2 Drehzahlstufen je nach Modell

- Drehstrommotoren 230/400 V 50 Hz (bis 4 kW) und 400/690 V 50 Hz (für Leistungen über 4 kW)
- Betriebstemperatur: -25 °C ... $+50$ °C.

Ausführung:

- Korrosionsbeständig mit Polymer-Polyesterharz 190 °C nach Entfetten mit nanotechnischer Behandlung, phosphatfrei.
- Oberflächenqualität C4H.

Auf Anfrage:

- ATEX-Motoren und mit 2 Drehzahlstufen.
- Ausführung vollständig aus rostfreiem Stahl.
- Ausführung aus feuerverzinktem Stahl.
- Marine-Motoren für die Schifffahrt, mit Zertifikat für Grundversorgung gemäß verschiedenen Klassifizierungsstellen (BV, DNV, LR).
- Motoren CE, NEMA, UL, CSA.
- Oberflächenqualität C5M.

Bestellnummer

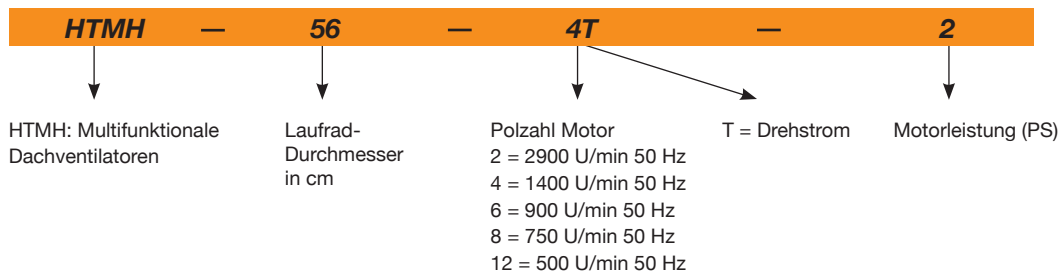

Technische Daten

Modell	Drehzahl (U/min)	Max. zulässige Stromaufnahme (A)			Installierte Leistung (kW)	Maximaler Volumenstrom (m³/h)	Schalldruckpegel ⁽¹⁾ dB(A)		Gewicht (ca.) (kg)	According ErP
		230 V	400 V	690 V			Saugseite	Druckseite		
HTMH-56-4T-1 IE3	1420	2,82	1,62		0,75	10545	62	59	79	2015
HTMH-56-4T-1.5 IE3	1455	4,07	2,34		1,10	11400	63	60	79	2015
HTMH-56-6T-0.75	910	2,59	1,49		0,55	8170	51	49	80	2015
HTMH-63-4T-1.5 IE3	1455	4,07	2,34		1,10	13870	65	62	94	2015
HTMH-63-4/8T-1.5	1440 / 710		2,90 / 1,30		1,10 / 0,25	13870 / 6935	65 / 50	62 / 47	94	2015
HTMH-63-4T-2 IE3	1440	5,41	3,11		1,50	15485	66	63	96	2015
HTMH-63-4/8T-2	1420 / 700		3,50 / 1,50		1,50 / 0,37	15485 / 7742	66 / 51	63 / 48	106	2015
HTMH-63-4T-3 IE3	1435	7,93	4,56		2,20	17955	67	64	108	2015
HTMH-63-4/8T-3	1430 / 710		4,90 / 1,70		2,20 / 0,45	17955 / 8977	67 / 52	64 / 49	112	2015
HTMH-63-6T-0.75	910	2,59	1,49		0,55	10260	56	54	95	2015
HTMH-63-6T-1 IE3	940	3,36	1,93		0,75	11305	57	55	95	2015
HTMH-71-4T-2 IE3	1440	5,41	3,11		1,50	16150	69	66	109	2015

Technische Daten

Modell	Drehzahl (U/min)	Max. zulässige Stromaufnahme (A)			Installierte Leistung (kW)	Maximaler Volumenstrom (m³/h)	Schalldruckpegel ⁽¹⁾ dB(A)		Gewicht (ca.) (kg)	According ErP
		230 V	400 V	690 V			Saugseite	Druckseite		
HTMH-71-4/8T-2	1420 / 700		3,50 / 1,50		1,50 / 0,37	16150 / 8075	69 / 54	66 / 51	119	2015
HTMH-71-4T-3 IE3	1435	7,93	4,56		2,20	18430	71	68	122	2015
HTMH-71-4/8T-3	1430 / 710		4,90 / 1,70		2,20 / 0,45	18430 / 9215	71 / 56	68 / 53	125	2015
HTMH-71-4T-4 IE3	1440	10,70	6,15		3,00	22610	72	69	133	2015
HTMH-71-4/8T-4	1430 / 710		6,50 / 2,30		3,00 / 0,60	22610 / 11305	72 / 57	69 / 54	135	2015
HTMH-71-6T-1 IE3	940	3,36	1,93		0,75	13205	58	56	109	2015
HTMH-71-6T-1.5 IE3	945	4,68	2,69		1,10	16245	59	57	116	2015
HTMH-80-4T-4 IE3	1440	10,70	6,15		3,00	27600	73	70	163	2015
HTMH-80-4/8T-4	1430 / 710		6,50 / 2,30		3,00 / 0,60	27600 / 13800	73 / 58	70 / 55	165	2015
HTMH-80-4T-5.5 IE3	1450	13,90	8,00		4,00	30176	74	71	163	2015
HTMH-80-4/8T-5.5	1430 / 710		8,20 / 2,90		4,00 / 0,80	30176 / 15088	74 / 59	71 / 56	195	2015
HTMH-80-6T-1.5 IE3	945	4,68	2,69		1,10	19412	62	60	145	2015
HTMH-80-6T-2 IE3	950	6,43	3,70		1,50	22172	63	61	148	2015
HTMH-80-6T-3 IE3	950	9,08	5,22		2,20	24932	64	62	160	2015
HTMH-90-4T-5.5 IE3	1450	13,90	8,00		4,00	35052	79	76	208	2015
HTMH-90-4/8T-5.5	1430 / 710		8,20 / 2,90		4,00 / 0,80	35052 / 17526	79 / 64	76 / 61	238	2015
HTMH-90-4T-7.5 IE3	1465		10,30	5,97	5,50	38456	81	78	240	2015
HTMH-90-4/8T-7.5	1450 / 720		11,80 / 3,80		5,50 / 1,10	38456 / 19228	81 / 66	78 / 63	243	2015
HTMH-90-4T-10 IE3	1465		13,90	8,06	7,50	41308	82	79	244	2015
HTMH-90-4/8T-9	1460 / 725		15,30 / 5,40		7,50 / 1,50	41308 / 20654	82 / 67	79 / 64	243	2015
HTMH-90-6T-3 IE3	950	9,08	5,22		2,20	29256	68	66	205	2015
HTMH-90-6/12T-3	940 / 470		5,60 / 2,20		2,20 / 0,37	29256 / 14628	68 / 53	66 / 51	245	2015
HTMH-90-6T-4 IE3	970	12,00	6,91		3,00	32016	69	67	235	2015
HTMH-90-6/12T-4	960 / 480		9,00 / 3,50		3,00 / 0,55	32016 / 16008	69 / 54	67 / 52	245	2015
HTMH-90-8T-1	705	4,68	2,70		0,75	17020	61	60	196	2015
HTMH-90-8T-2	705	7,10	4,10		1,50	19596	63	62	208	2015
HTMH-100-4T-7.5 IE3	1465		10,30	5,97	5,50	40756	84	81	265	2015
HTMH-100-4/8T-7.5	1450 / 720		11,80 / 3,80		5,50 / 1,10	40756 / 20378	84 / 69	81 / 66	269	2015
HTMH-100-4T-10 IE3	1465		13,90	8,06	7,50	47564	85	82	269	2015
HTMH-100-4/8T-9	1460 / 725		15,30 / 5,40		7,50 / 1,50	44528 / 22264	84 / 69	81 / 66	269	2015
HTMH-100-4T-15 IE3	1470		20,90	12,10	11,00	51336	86	83	332	2015
HTMH-100-6T-3 IE3	950	9,08	5,22		2,20	32476	74	72	231	2015
HTMH-100-6/12T-3	940 / 470		5,60 / 2,20		2,20 / 0,37	32476 / 16238	74 / 59	72 / 57	271	2015
HTMH-100-6T-4 IE3	970	12,00	6,91		3,00	35420	75	73	260	2015
HTMH-100-6T-5.5 IE3	960	15,60	8,99		4,00	40020	76	74	277	2015
HTMH-100-6/12T-5.5	970 / 480		11 / 4		4,00 / 0,65	40020 / 20010	76 / 61	74 / 59	289	2015
HTMH-125-4T/6-15 IE3	1470		21,40	12,40	11,00	66800	76	73	398	2015
HTMH-125-4T/6-20 IE3	1340		1,00		15,00	72900	76	73	393	2015
HTMH-125-4T/9-20 IE3	1340		1,00		15,00	76310	75	72	408	2015
HTMH-125-6T/6-5.5 IE3	960	15,60	8,99		4,00	47760	63	61	343	2015
HTMH-125-6T/6-7.5 IE3	970		11,20	6,49	5,50	55600	63	61	347	2015
HTMH-125-6T/6-10 IE3	970		14,80	8,58	7,50	66170	65	63	369	2015
HTMH-125-6T/6-15 IE3	970		22,00	12,80	11,00	76380	67	65	399	2015
HTMH-125-6T/9-7.5 IE3	970		11,20	6,49	5,50	50000	64	62	362	2015
HTMH-125-6T/9-10 IE3	970		14,80	8,58	7,50	59340	64	62	384	2015
HTMH-125-6T/9-15 IE3	970		22,00	12,80	11,00	71890	67	65	414	2015
HTMH-125-6T/9-20 IE3	975		28,00	16,20	15,00	83660	70	68	467	2015
HTMH-125-8T/6-4	705	12,82	7,40		3,00	47510	56	55	328	2015
HTMH-125-8T/6-5.5	710	16,11	9,30		4,00	52770	58	57	345	2015
HTMH-125-8T/6-7.5	710		12,00	7,20	5,50	60410	60	59	361	2015
HTMH-125-8T/6-10	725		16,00	9,50	7,50	66030	61	60	389	2015
HTMH-125-8T/9-5.5	710	16,11	9,30		4,00	51330	58	57	360	2015
HTMH-125-8T/9-7.5	710		12,00	7,20	5,50	54480	61	60	376	2015
HTMH-125-8T/9-10	725		16,00	9,50	7,50	65660	63	62	404	2015
HTMH-125-8T/9-15	720		24,00	13,80	11,00	73870	64	63	426	2015

(1) Die angegebenen Schalldruckpegel sind Drücke in dB(A), gemessen im Abstand von 14 m im freien Feld.

Geräuschemissionswerte

Spektrum des Schalleistungspegels Lw(A) in dB(A) Frequenzband in [Hz]

Werte an Saugseite mit max. Volumenstrom gemessen.

Modell	63	125	250	500	1000	2000	4000	8000
56-4-1	46	67	74	79	82	78	71	60
56-4-1.5	47	68	75	80	83	79	72	61
56-6-0.75	35	56	63	68	71	67	60	49
63-4-1.5	49	70	77	82	85	81	74	63
63-4-2	50	71	78	83	86	82	75	64
63-4-3	51	72	79	84	87	83	76	65
63-6-0.75	40	61	68	73	76	72	65	54
63-6-1	41	62	69	74	77	73	66	55
63-8-1.5	34	55	62	67	70	66	59	48
63-8-2	35	56	63	68	71	67	60	49
63-8-3	36	57	64	69	72	68	61	50
71-4-2	53	74	81	86	89	85	78	67
71-4-3	55	76	83	88	91	87	80	69
71-4-4	56	77	84	89	92	88	81	70
71-6-1	42	63	70	75	78	74	67	56
71-6-1.5	43	64	71	76	79	75	68	57
71-8-2	38	59	66	71	74	70	63	52
71-8-3	40	61	68	73	76	72	65	54
71-8-4	41	62	69	74	77	73	66	55
80-4-4	57	78	85	90	93	89	82	71
80-4-5.5	58	79	86	91	94	90	83	72
80-6-1.5	46	67	74	79	82	78	71	60
80-6-2	47	68	75	80	83	79	72	61
80-6-3	48	69	76	81	84	80	73	62
80-8-4	42	63	70	75	78	74	67	56
80-8-5.5	43	64	71	76	79	75	68	57
90-4-5.5	63	84	91	96	99	95	88	77
90-4-7.5	65	86	93	98	101	97	90	79
90-4-9	66	87	94	99	102	98	91	80
90-4-10	66	87	94	99	102	98	91	80
90-6-3	52	73	80	85	88	84	77	66
90-6-4	53	74	81	86	89	85	78	67
90-8-1	45	66	73	78	81	77	70	59
90-8-2	47	68	75	80	83	79	72	61
90-8-5.5	48	69	76	81	84	80	73	62
90-8-7.5	50	71	78	83	86	82	75	64
90-8-9	51	72	79	84	87	83	76	65
90-12-3	37	58	65	70	73	69	62	51
90-12-4	38	59	66	71	74	70	63	52
100-4-7.5	68	89	96	101	104	100	93	82
100-4-9	68	89	96	101	104	100	93	82
100-4-10	69	90	97	102	105	101	94	83
100-4-15	70	91	98	103	106	102	95	84
100-6-3	58	79	86	91	94	90	83	72
100-6-4	59	80	87	92	95	91	84	73
100-6-5.5	60	81	88	93	96	92	85	74
100-8-7.5	53	74	81	86	89	85	78	67
100-8-9	53	74	81	86	89	85	78	67
100-12-3	43	64	71	76	79	75	68	57
100-12-5.5	45	66	73	78	81	77	70	59
125-4T/6-15	63	72	87	94	97	91	85	81
125-4T/6-20	63	72	87	94	97	91	85	81
125-4T/9-20	62	71	87	93	95	89	84	80
125-6T/6-5.5	56	66	78	81	83	79	68	64
125-6T/6-7.5	56	66	78	81	83	79	68	64
125-6T/6-10	58	68	80	83	85	81	70	66
125-6T/6-15	60	70	82	85	87	83	72	68
125-6T/9-7.5	54	65	79	83	83	81	70	66
125-6T/9-10	54	65	79	83	83	81	70	66
125-6T/9-15	57	68	82	86	86	84	73	69
125-6T/9-20	60	71	85	89	89	87	76	72
125-8T/6-4	50	59	70	75	75	69	58	54
125-8T/6-5.5	52	61	72	77	77	71	60	56
125-8T/6-7.5	54	63	74	79	79	73	62	58
125-8T/6-10	55	64	75	80	80	74	63	59
125-8T/9-5.5	49	61	70	76	78	72	61	57
125-8T/9-7.5	52	64	73	79	81	75	64	60
125-8T/9-10	54	66	75	81	83	77	66	62
125-8T/9-15	55	67	76	82	84	78	67	63

Werte an Druckseite mit max. Volumenstrom gemessen.

Modell	63	125	250	500	1000	2000	4000	8000
56-4-1	43	64	71	76	79	75	68	57
56-4-1.5	44	65	72	77	80	76	69	58
56-6-0.75	33	54	61	66	69	65	58	47
63-4-1.5	46	67	74	79	82	78	71	60
63-4-2	47	68	75	80	83	79	72	61
63-4-3	48	69	76	81	84	80	73	62
63-6-0.75	38	59	66	71	74	70	63	52
63-6-1	39	60	67	72	75	71	64	53
63-8-1.5	31	52	59	64	67	63	56	45
63-8-2	32	53	60	65	68	64	57	46
63-8-3	33	54	61	66	69	65	58	47
71-4-2	50	71	78	83	86	82	75	64
71-4-3	52	73	80	85	88	84	77	66
71-4-4	53	74	81	86	89	85	78	67
71-6-1	40	61	68	73	76	72	65	54
71-6-1.5	41	62	69	74	77	73	66	55
71-8-2	35	56	63	68	71	67	60	49
71-8-3	37	58	65	70	73	69	62	51
71-8-4	38	59	66	71	74	70	63	52
80-4-4	54	75	82	87	90	86	79	68
80-4-5.5	55	76	83	88	91	87	80	69
80-6-1.5	44	65	72	77	80	76	69	58
80-6-2	45	66	73	78	81	77	70	59
80-6-3	46	67	74	79	82	78	71	60
80-8-4	39	60	67	72	75	71	64	53
80-8-5.5	40	61	68	73	76	72	65	54
90-4-5.5	60	81	88	93	96	92	85	74
90-4-7.5	62	83	90	95	98	94	87	76
90-4-9	63	84	91	96	99	95	88	77
90-4-10	63	84	91	96	99	95	88	77
90-6-3	50	71	78	83	86	82	75	64
90-6-4	51	72	79	84	87	83	76	65
90-8-1	44	65	72	77	80	76	69	58
90-8-2	46	67	74	79	82	78	71	60
90-8-5.5	45	66	73	78	81	77	70	59
90-8-7.5	47	68	75	80	83	79	72	61
90-8-9	48	69	76	81	84	80	73	62
90-12-3	35	56	63	68	71	67	60	49
90-12-4	36	57	64	69	72	68	61	50
100-4-7.5	65	86	93	98	101	97	90	79
100-4-9	65	86	93	98	101	97	90	79
100-4-10	66	87	94	99	102	98	91	80
100-4-15	67	88	95	100	103	99	92	81
100-6-3	56	77	84	89	92	88	81	70
100-6-4	57	78	85	90	93	89	82	71
100-6-5.5	58	79	86	91	94	90	83	72
100-8-7.5	50	71	78	83	86	82	75	64
100-8-9	50	71	78	83	86	82	75	64
100-12-3	41	62	69	74	77	73	66	55
100-12-5.5	43	64	71	76	79	75	68	57
125-4T/6-15	60	69	84	91	94	88	82	78
125-4T/6-20	60	69	84	91	94	88	82	78
125-4T/9-20	59	68	84	90	92	86	81	77
125-6T/6-5.5	54	64	76	79	81	77	66	62
125-6T/6-7.5	54	64	76	79	81	77	66	62
125-6T/6-10	56	66	78	81	83	79	68	64
125-6T/6-15	58	68	80	83	85	81	70	66
125-6T/9-7.5	52	63	77	81	81	79	68	64
125-6T/9-10	52	63	77	81	81	79	68	64
125-6T/9-15	55	66	80	84	84	82	71	67
125-6T/9-20	58	69	83	87	87	85	74	70
125-8T/6-4	49	58	69	74	74	68	57	53
125-8T/6-5.5	51	60	71	76	76	70	59	55
125-8T/6-7.5	53	62	73	78	78	72	61	57
125-8T/6-10	54	63	74	79	79	73	62	58
125-8T/9-5.5	48	60	69	75	77	71	60	56
125-8T/9-7.5	51	63	72	78	80	74	63	59
125-8T/9-10	53	65	74	80	82	76	65	61
125-8T/9-15	54	66	75	81	83	77	66	62



Erp. (Energy Related Products)

Informationen über die Richtlinie 2009/125/EG können auf der SODECA-Website oder den QuickFan-Selector heruntergeladen werden.

Abmessungen mm

Modell	A	B	C	D	F	G	H	I
HTMH-56	650	185	425	40	960	900	750	14
HTMH-63	680	215	425	40	1092	1000	850	14
HTMH-71	760	195	525	40	1120	1000	850	14
HTMH-80	790	215	525	50	1252	1150	1000	14
HTMH-90	910	232	638	40	1380	1150	1000	14
HTMH-100	1055	252	753	50	1527	1250	1100	14
HTMH-125	1170	312	808	50	1802	1425	1275	17

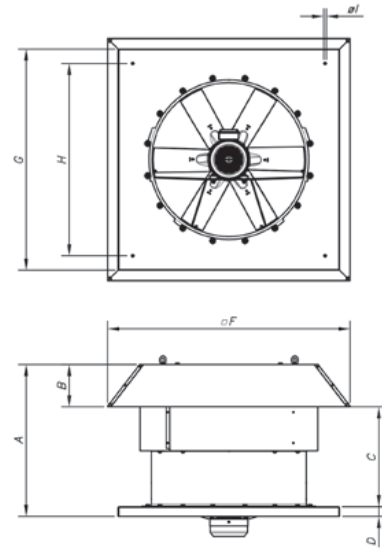

Kennlinien

Q= Volumenstrom in m³/h, m³/s und CFM

Pe= statischer Druck mmH₂O, Pa und inwg

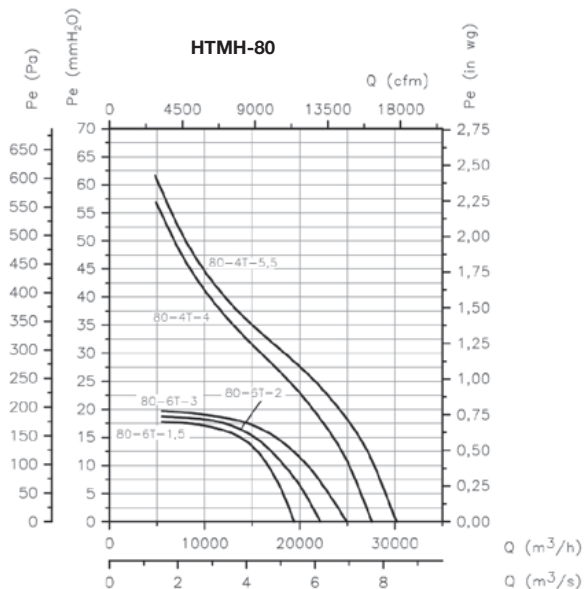
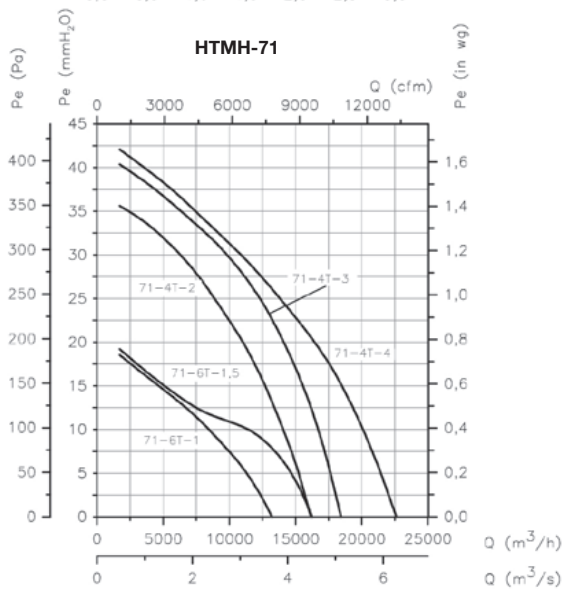
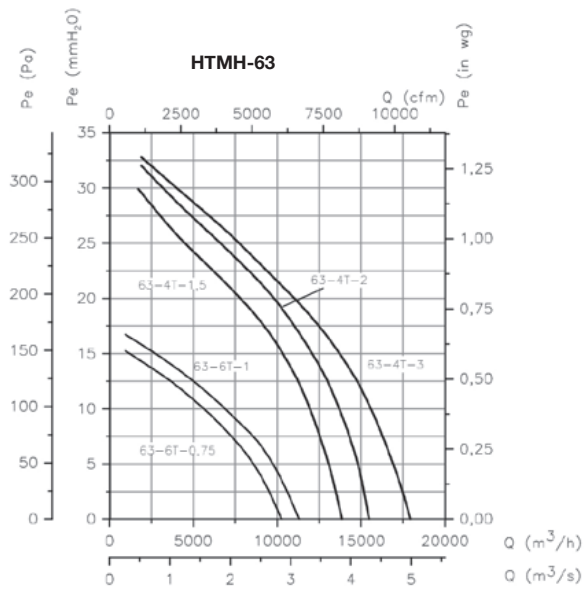
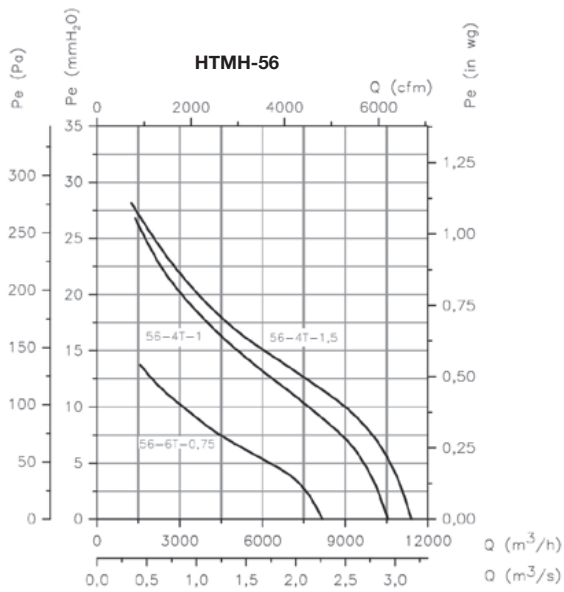

Kennlinien

Q= Volumenstrom in m³/h, m³/s und CFM

Pe= statischer Druck mmH₂O, Pa und inwg

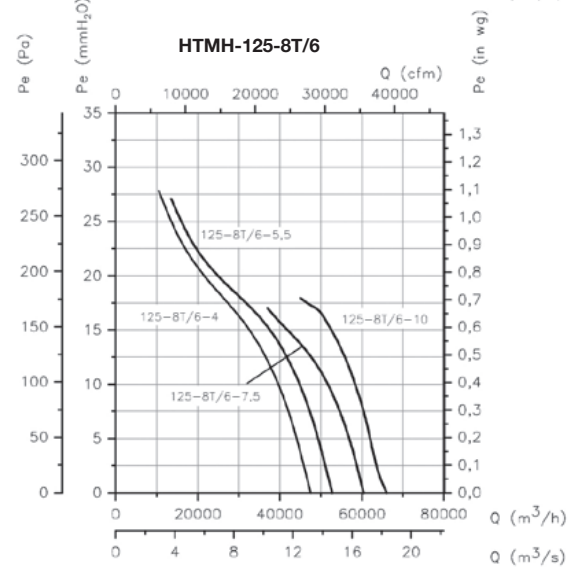
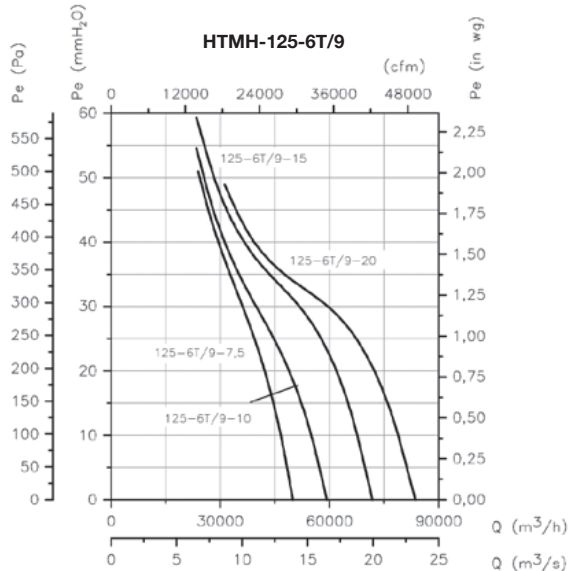
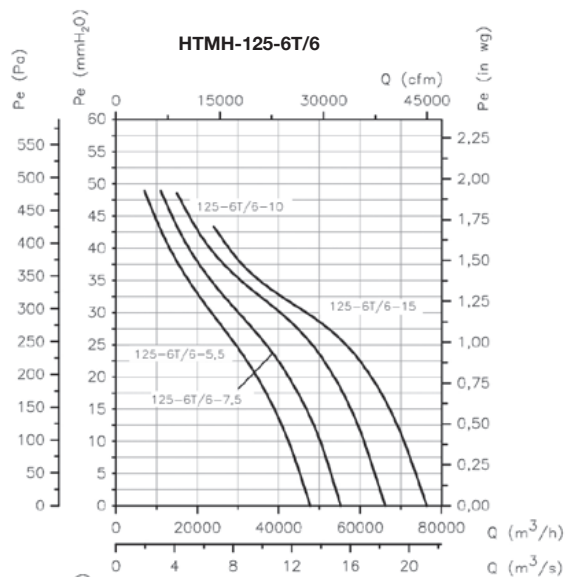
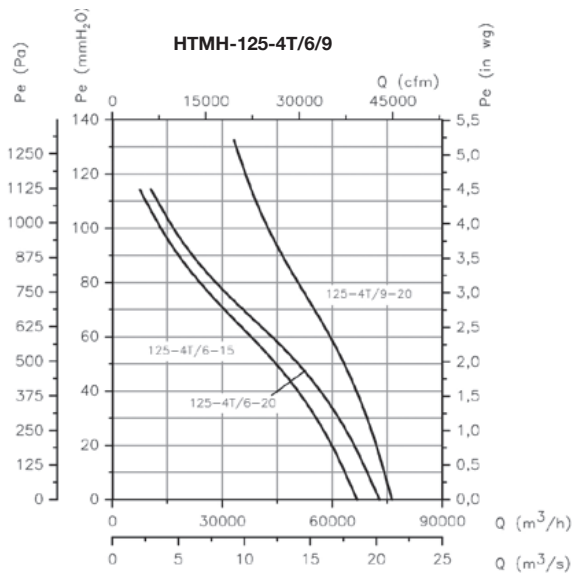
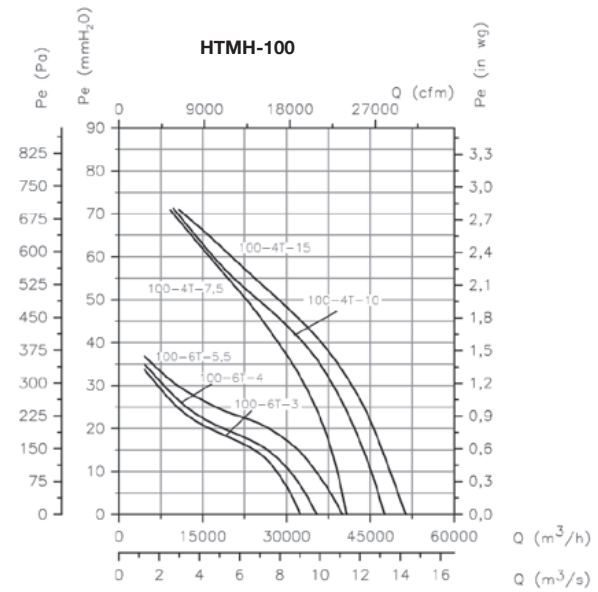
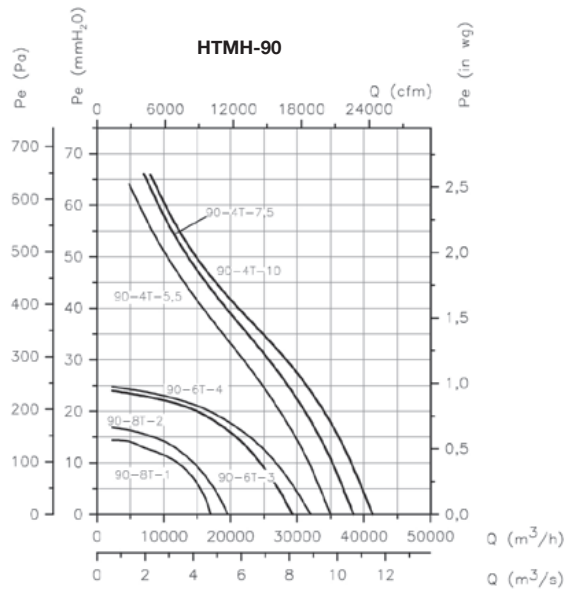

Kennlinien

Q= Volumenstrom in m³/h, m³/s und CFM

Pe= statischer Druck mmH₂O, Pa und inwg

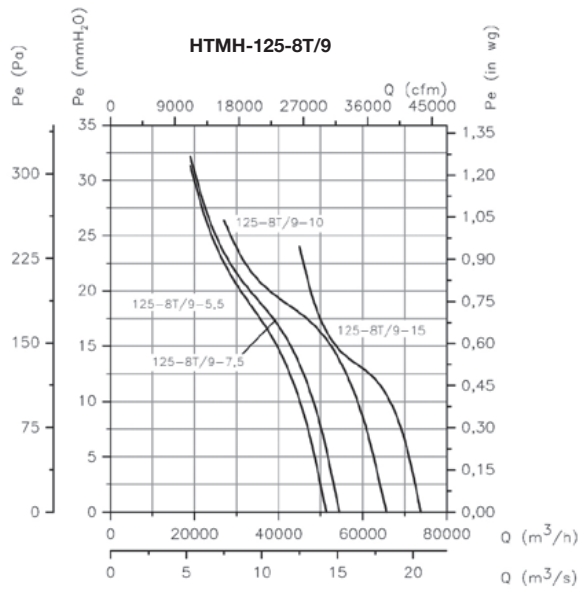

Validierung des Schalldrucks je nach Abstand

Der Schalleistungspegel kann sich je nach Konstruktion des Daches oder der Decke ändern.

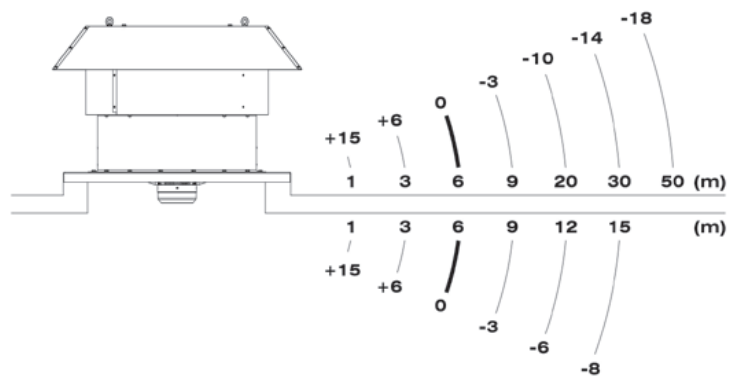

Zubehör

