

HFW

Hot dip galvanised tubular fans

Tubular axial fans designed with four support arms to reduce vibrations and fitted with an aerodynamic aluminium low-consumption rotor.



Fan:

- Airflow direction from Motor to Impeller.
- AL version rotors made of cast aluminium.
- Support ring made of sheet steel with double flange and cable gland for motor power supply.
- Hot dip galvanised sheet steel tubular casing.

Motor:

- IE3 efficiency motors for powers equal to or greater than 0.75kW except single-phase, 2-speed and 8-pole.
- Class F motors with ball bearings and IP55 protection.
- Multi voltage motor, special design valid for 220/380V 60Hz, 254/440V 60Hz, 265/460V 60Hz, 277/480V 60Hz.
- Operating temperature: -25°C +50 °C.

Finish:

- Hot dip galvanised.

On request:

- Airflow direction from Impeller to Motor.
- Fibreglass-reinforced polyamide PL version rotors.
- Rotors 100% reversible.
- Special windings for different voltages.
- ATEX-certified Category 2

Order code

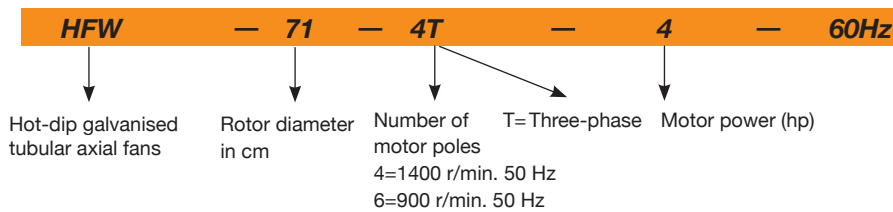

60Hz

Technical characteristics

Model	Speed (r/min)	Max. admissible current (A)		Installed power (kW)	Blade inclination angle (°)	Max. flow rate (m³/h)	Sound pressure level dB(A)	Approx. weight (kg)
		220-277V	380-480V					
HFW-56-4T-1	1692	3.10	1.79	0.75	22	11250	76.65	28
HFW-56-4T-1.5	1680	4.03	2.32	1.10	30	13600	77.70	32
HFW-56-4T-2	1716	5.96	3.44	1.50	36	15050	78.75	30
HFW-56-6T-0.75	1092	2.59	1.49	0.55	38	10150	65.10	23
HFW-63-4T-1	1692	3.10	1.79	0.75	14	15200	76.65	29
HFW-63-4T-1.5	1680	4.03	2.32	1.10	20	17800	77.70	32
HFW-63-4T-2	1716	5.96	3.44	1.50	24	19300	78.75	35
HFW-63-4T-3	1734	8.36	4.83	2.20	32	22150	79.80	43
HFW-63-4T-4	1734	10.96	6.33	3.00	38	24250	80.85	45
HFW-63-6T-0.75	1092	2.59	1.49	0.55	28	13600	68.25	29
HFW-63-6T-1	1134	3.90	2.20	0.75	38	15900	69.30	35
HFW-71-4T-1.5	1680	4.03	2.32	1.10	12	19500	81.90	35
HFW-71-4T-2	1716	5.96	3.44	1.50	14	20900	82.95	38
HFW-71-4T-3	1734	8.36	4.83	2.20	22	25100	85.05	47
HFW-71-4T-4	1734	10.96	6.33	3.00	28	27500	86.10	49
HFW-71-6T-0.75	1092	2.59	1.49	0.55	20	16100	70.35	31
HFW-71-6T-1	1134	3.90	2.20	0.75	26	17300	71.40	38
HFW-71-6T-1.5	1134	4.88	2.82	1.10	34	19950	72.45	40
HFW-80-4T-3	1734	8.36	4.83	2.20	12	25450	86.10	55
HFW-80-4T-4	1734	10.96	6.33	3.00	16	30250	87.15	57
HFW-80-4T-5.5	1728	14.10	8.12	4.00	18	32750	88.20	62
HFW-80-6T-1.5	1134	4.88	2.82	1.10	18	21450	75.60	48
HFW-80-6T-2	1146	6.42	3.71	1.50	26	25950	76.65	54
HFW-80-6T-3	1146	9.30	5.30	2.20	32	29950	77.70	59
HFW-90-4T-4	1734	10.96	6.33	3.00	8	33600	91.35	66
HFW-90-4T-5.5	1728	14.10	8.12	4.00	12	38900	93.45	71
HFW-90-4T-7.5	1728		10.60	5.50	18	46150	95.55	87
HFW-90-4T-10 IE3	1758		8.06	7.50	22	50150	96.60	98
HFW-90-6T-2	1146	6.42	3.71	1.50	16	28800	80.85	63
HFW-90-6T-3	1146	9.30	5.30	2.20	24	34000	81.90	68
HFW-90-6T-4	1152	12.70	7.30	3.00	30	38900	82.95	92
HFW-100-4T-7.5	1728		10.60	5.50	10	46850	96.60	95
HFW-100-4T-10 IE3	1758		8.06	7.50	16	57400	97.65	106
HFW-100-4T-15 IE3	1764		20.90	11.00	22	66300	98.70	129
HFW-100-4T-20 IE3	1764		28.30	15.00	28	76150	99.75	148
HFW-100-6T-3	1146	9.30	5.30	2.20	16	37600	86.10	76
HFW-100-6T-4	1152	12.70	7.30	3.00	20	41150	87.15	100
HFW-100-6T-5.5	1152	16.50	9.46	4.00	26	47800	88.20	108

Acoustic characteristics

The indicated values are determined by measuring the sound pressure level and sound power in dB(A) obtained in a free field at a distance equivalent to twice the size of the fan plus the rotor diameter, with a minimum of 1.5 m.

Sound power spectrum Lw(A) in dB(A) per Hz frequency band

Model	63	125	250	500	1000	2000	4000	8000	Model	63	125	250	500	1000	2000	4000	8000
HFW-56-4T-1	48	68	76	81	83	80	73	62	HFW-80-4T-4	56	76	84	89	91	88	81	74
HFW-56-4T-1.5	49	69	77	82	84	81	74	63	HFW-80-4T-5.5	56	76	84	89	91	88	81	70
HFW-56-4T-2	50	70	78	83	85	82	75	64	HFW-80-6T-1.5	49	66	74	79	81	78	71	60
HFW-56-6T-0.75	37	57	65	70	72	69	62	51	HFW-80-6T-2	50	67	75	80	82	79	72	61
HFW-63-4T-1	50	70	78	83	85	82	75	64	HFW-80-6T-3	51	68	76	81	83	80	73	62
HFW-63-4T-1.5	48	68	76	81	83	80	73	65	HFW-90-4T-4	61	82	89	94	97	93	86	79
HFW-63-4T-2	52	68	76	81	83	80	73	66	HFW-90-4T-5.5	60	81	88	93	96	92	85	74
HFW-63-4T-3	53	70	78	83	85	82	77	67	HFW-90-4T-7.5	59	80	87	92	95	91	84	73
HFW-63-4T-4	54	71	79	84	86	83	78	68	HFW-90-4T-10	58	79	86	91	94	90	83	72
HFW-63-6T-0.75	42	60	68	73	75	72	65	56	HFW-90-6T-2	58	79	86	91	94	90	83	72
HFW-63-6T-1	43	62	70	75	77	74	67	57	HFW-90-6T-3	56	70	77	82	85	81	74	63
HFW-71-4T-1.5	54	74	82	87	89	86	79	69	HFW-90-6T-4	57	72	79	84	87	83	76	65
HFW-71-4T-2	53	73	81	86	88	85	78	70	HFW-100-4T-7.5	64	84	92	97	99	96	89	78
HFW-71-4T-3	58	72	80	85	87	84	77	71	HFW-100-4T-10	62	82	90	95	97	94	87	76
HFW-71-4T-4	59	73	81	86	88	85	78	72	HFW-100-4T-15	61	81	89	94	96	93	86	75
HFW-71-6T-0.75	44	63	72	74	76	73	66	55	HFW-100-4T-20	63	83	91	96	98	95	88	77
HFW-71-6T-1	45	65	73	75	77	74	67	56	HFW-100-6T-3	61	72	80	85	87	84	77	66
HFW-71-6T-1.5	46	66	71	76	78	75	68	57	HFW-100-6T-4	64	72	80	85	87	84	77	66
HFW-80-4T-3	57	77	85	90	92	89	82	73	HFW-100-6T-5.5	64	73	81	86	88	85	78	67

Dimensions mm

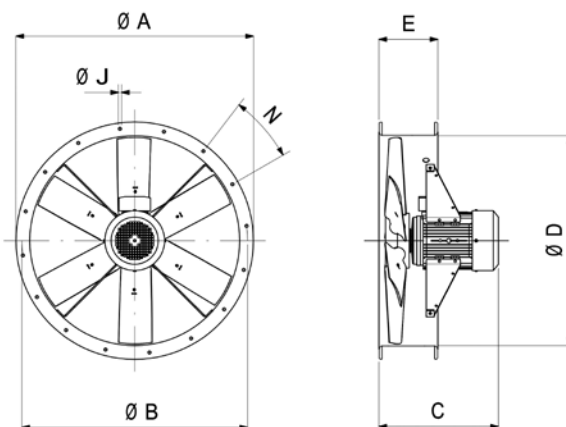

	ØA	ØB	0.75	1	1.5	2	3	C	4	5.5	7.5	10	15	20	ØD	E	ØJ	N
HFW-56-4	665	620	-	330	380	380	-	-	-	-	-	-	-	-	560	225	12	12x30°
HFW-56-6	665	620	330	-	-	-	-	-	-	-	-	-	-	-	560	225	12	12x30°
HFW-63-4	735	690	-	379	429	429	470	470	-	-	-	-	-	-	640	225	12	12x30°
HFW-63-6	735	690	379	429	-	-	-	-	-	-	-	-	-	-	640	225	12	12x30°
HFW-71-4	815	770	-	-	389	389	430	430	-	-	-	-	-	-	710	225	12	16x22°30'
HFW-71-6	815	770	339	389	389	-	-	-	-	-	-	-	-	-	710	225	12	16x22°30'
HFW-80-4	905	860	-	-	-	-	436	436	460	-	-	-	-	-	800	225	12	16x22°30'
HFW-80-6	905	860	-	-	395	436	460	-	-	-	-	-	-	-	800	225	12	16x22°30'
HFW-90-4	1018	970	-	-	-	-	-	401	425	485	525	-	-	-	900	225	15	16x22°30'
HFW-90-6	1018	970	-	-	-	401	425	485	-	-	-	-	-	-	900	225	15	16x22°30'
HFW-100-4	1118	1070	-	-	-	-	-	-	-	488	528	643	703	1000	225	15	16x22°30'	
HFW-100-6	1118	1070	-	-	-	-	428	488	528	-	-	-	-	-	1000	225	15	16x22°30'

Accessories

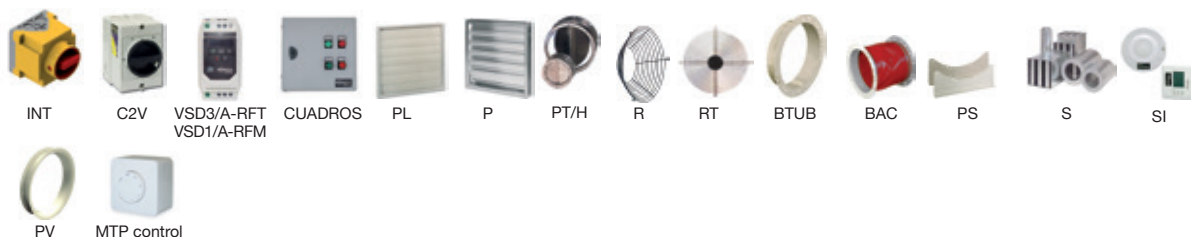

Characteristic curves

Q= Flow rate in m³/h, m³/s and cfm.

Pe= Static pressure in mm H₂O, Pa and inwg.

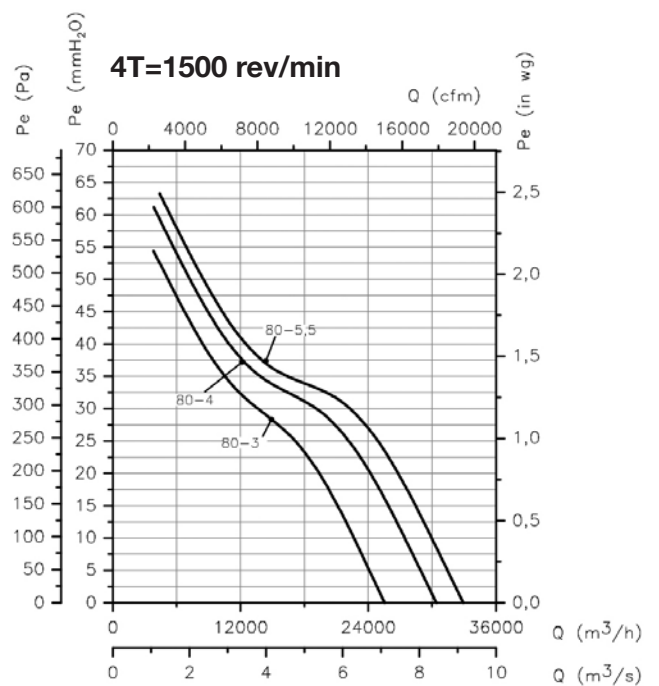
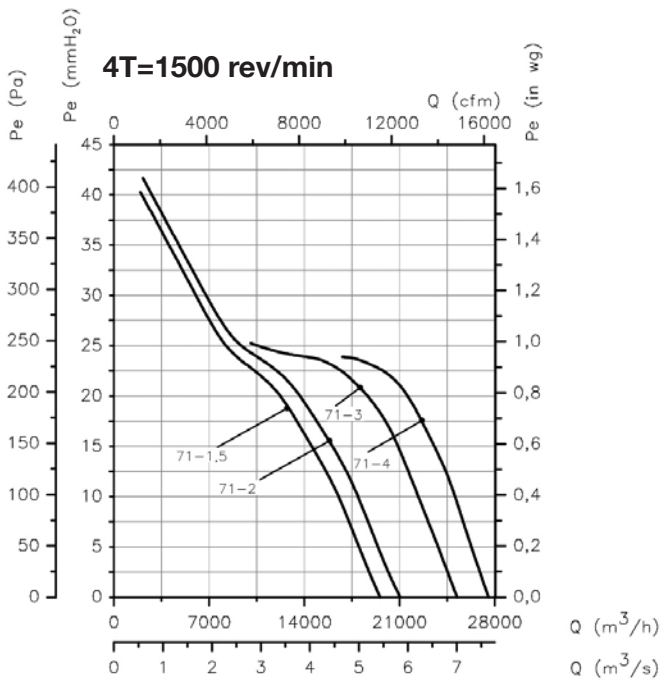
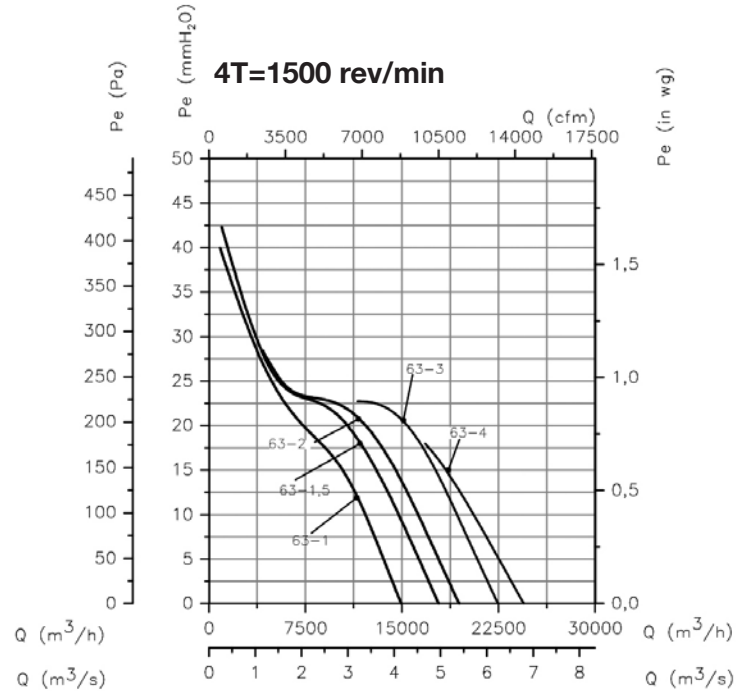
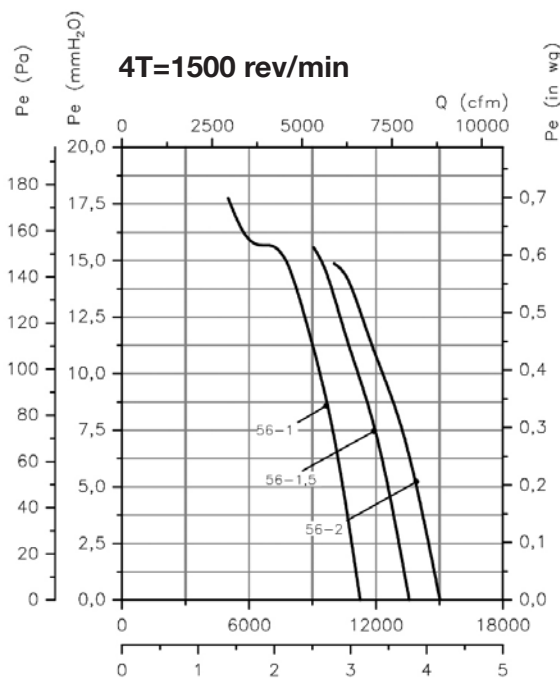

Characteristic curves

Q= Flow rate in m³/h, m³/s and cfm.

Pe= Static pressure in mm H₂O, Pa and inwg.

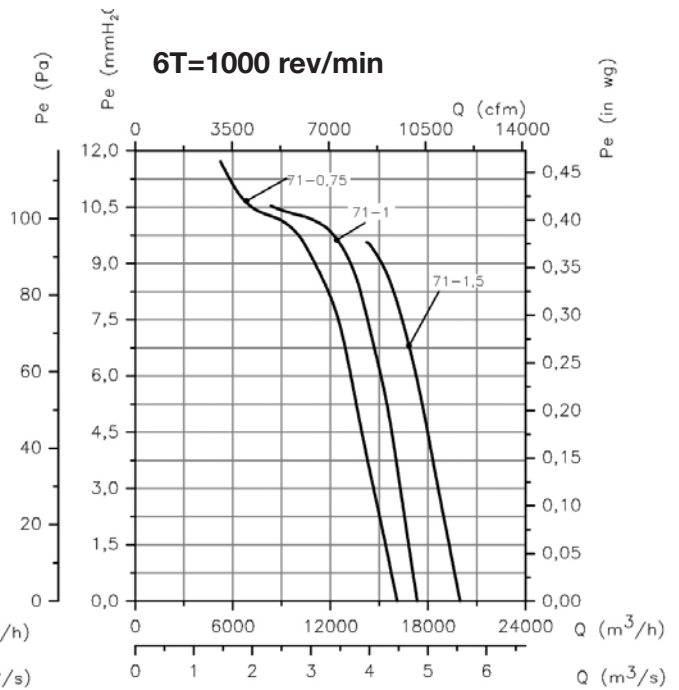
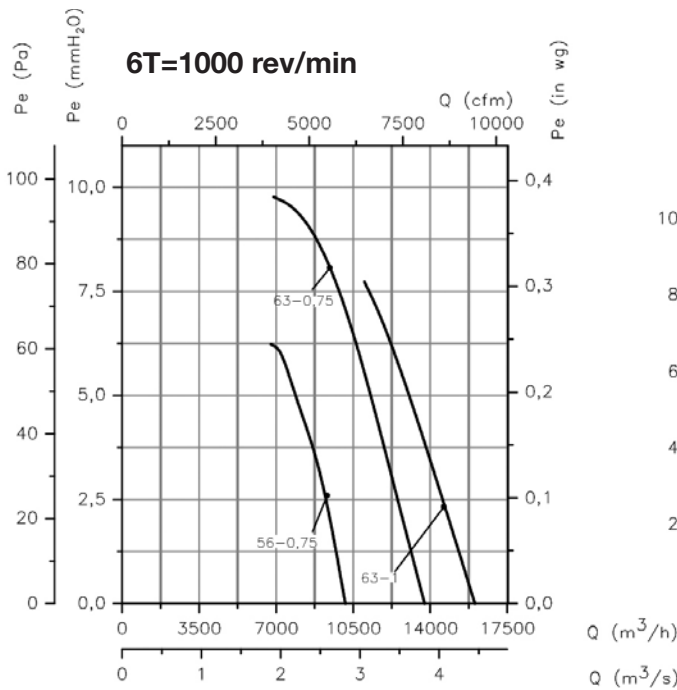
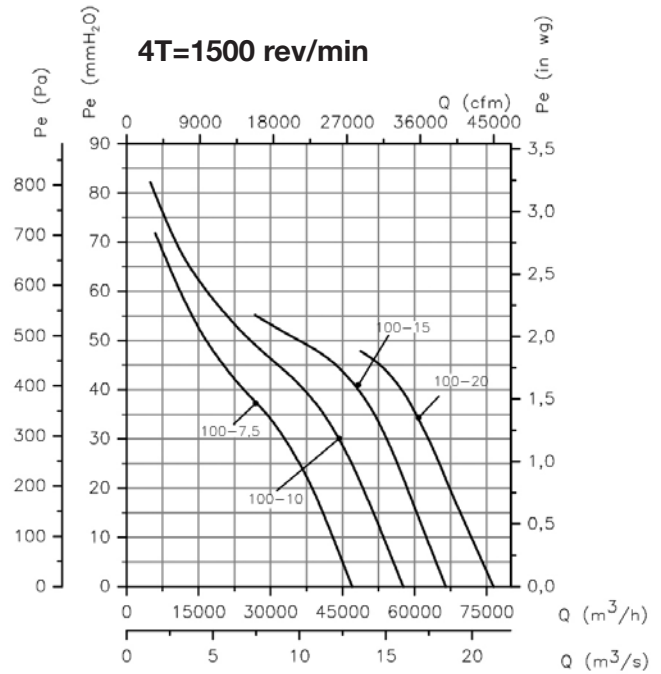
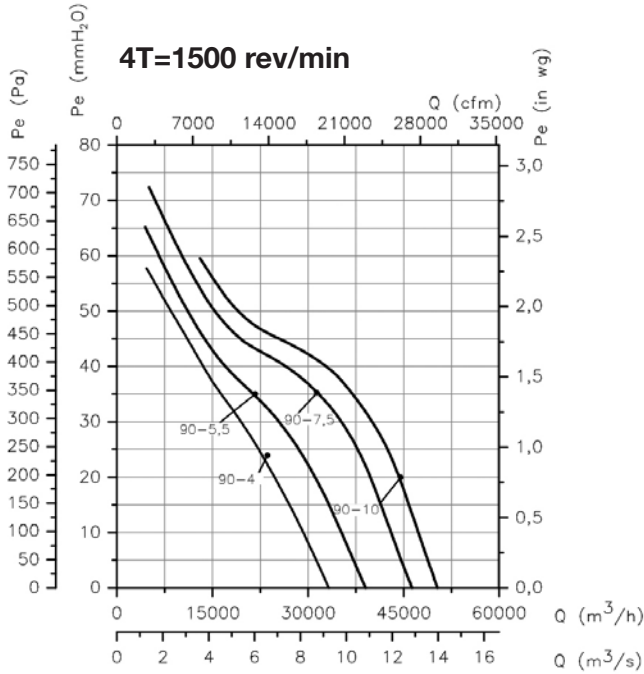

Characteristic curves

Q= Flow rate in m³/h, m³/s and cfm.

Pe= Static pressure in mm H₂O, Pa and inwg.

