

HC



Wall-mounted axial fans with IP55 motors



HC



HC 71, 80, 90, 100

Wall-mounted axial fans with reinforced plastic impeller made of fibreglass.

Fan:

- Sheet steel support frame.
- Fibreglass-reinforced polyamide-6 impeller.
- Anti-contact protective grille pursuant to standard UNE-EN ISO 12499.
- Models 71, 80, 90 and 100, protective grille supplied as an accessory
- Airflow direction from motor to impeller.

Motor:

- IE3 efficiency motors for powers equal to or higher than 0.75kW except single-phase, 2-speed and 8-pole.
- Class F motors with ball bearings, IP55 protection, except single-phase models from size 45 to size 63, IP54 protection. 1 or 2 speeds, depending on model

- Single-phase 230V-50Hz and three-phase 230/400V-50Hz (up to 4kW) and 400/690V 50Hz (powers higher than 4kW)
- Operating temperature: -25 °C +60 °C.

Finish:

- Anti-corrosive finish of polyester resin polymerised at 190°C, previously degreased with phosphate-free nanotechnological treatment.

On request:

- Motor, impeller and grille assembly (F version), except models 71, 80, 90 and 100, which are supplied without a grille.
- Motor impeller unit, version G.
- Airflow direction from impeller to motor.
- Special windings for different voltages.

Order code

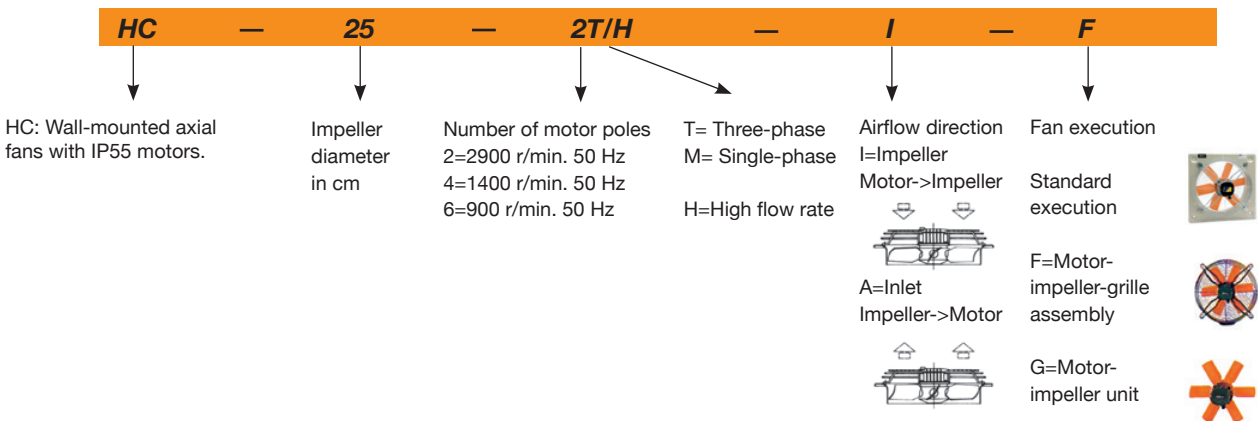

Technical characteristics

Model	Speed (r/min)	Maximum admissible current (A)			Installed power (kW)	Maximum flow rate (m³/h)	Sound pressure level dB(A)	Approx. weight (kg)	According to ErP
		230V	400V	690V					
HC-25-2T/H	2730	0.70	0.40		0.12	2200	64	5	2015
HC-25-2M/H	2730	1.10			0.12	2200	64	5	*
HC-25-4T/H	1350	1.10	0.60		0.09	1300	51	5	Excluded
HC-25-4M/H	1350	1.10			0.09	1300	51	5	Excluded
HC-31-2T/H	2750	1.21	0.70		0.18	3650	72	6	2015

Technical characteristics

Model	Speed (r/min)	Maximum admissible current (A)			Installed power (kW)	Maximum flow rate (m ³ /h)	Sound pressure level dB(A)	Approx. weight (kg)	According to ErP
		230V	400V	690V					
HC-31-2M/H	2700	1.85			0.18	3600	72	6	2015
HC-31-4T/H	1350	1.10	0.60		0.09	2400	54	6	Excluded
HC-31-4M/H	1430	0.99			0.10	2400	54	6	Excluded
HC-35-2T/H	2710	1.92	1.11		0.37	6050	76	8	2015
HC-35-4T/H	1350	1.10	0.60		0.09	3550	58	7	2015
HC-35-4M/H	1440	1.08			0.10	3550	58	7	2015
HC-40-4T/H	1350	1.66	0.96		0.25	5200	63	10	2015
HC-40-4M/H	1370	2.00			0.25	5200	63	10	2015
HC-40-6T/H	900	1.51	0.87		0.25	3700	55	10	2015
HC-40-6M/H	970	1.30			0.25	3700	55	10	*
HC-45-4T/H	1370	2.02	1.17		0.37	7300	66	14	2015
HC-45-4M/H	1400	2.76			0.37	7300	66	14	2015
HC-45-6T/H	900	1.51	0.87		0.25	5150	57	14	2015
HC-45-6M/H	950	1.50			0.25	5150	57	14	2015
HC-50-4T/H	1380	2.92	1.69		0.55	10200	69	18	2015
HC-50-4M/H	1350	5.02			0.55	10200	69	18	2015
HC-50-6T/H	900	2.24	1.30		0.37	6300	59	18	2015
HC-50-6M/H	900	2.69			0.37	6300	59	18	*
HC-56-4T/H IE3	1455	4.07	2.34		1.10	13000	72	28	2015
HC-56-6T/H	900	2.24	1.30		0.37	8300	61	19	2015
HC-56-6M/H	900	2.69			0.37	8300	61	19	2015
HC-63-4T/H IE3	1455	4.07	2.34		1.10	16450	74	30	2015
HC-63-6T/H	900	2.24	1.30		0.37	12350	64	21	2015
HC-63-6M/H	890	3.00			0.37	12350	64	21	2015
HC-71-4T/H IE3	1440	5.41	3.11		1.50	22150	78	43	2015
HC-71-6T/H IE3	940	3.36	1.93		0.75	17300	66	39	2015
HC-71-6M/H	900	4.97			0.75	15600	65	36	2015
HC-80-4T/H IE3	1440	10.70	6.15		3.00	33000	82	60	2015
HC-80-6T/H IE3	940	3.36	1.93		0.75	22000	71	48	2015
HC-90-4T/H IE3	1450	13.90	8.00		4.00	43700	86	70	2015
HC-90-6T/H IE3	950	6.43	3.70		1.50	33300	76	64	2015
HC-100-4T/H IE3	1465		10.30	5.97	5.50	54000	88	108	2015
HC-100-6T/H IE3	950	6.43	3.70		1.50	37000	78	67	2015

* Equipment not covered by Directive 2009/125/EC



Erp. (Energy Related Products)

Information on Directive 2009/125/EC can be downloaded from the SODECA website or the QuickFan selector programme.

Acoustic characteristics

The indicated values are determined by measuring the pressure and sound power levels in dB(A) obtained in a free field at a distance equivalent to twice the size of the fan plus the impeller diameter, with a minimum of 1.5 m.

Noise power spectrum Lw(A) in dB(A) frequency band in [Hz]

Model	63	125	250	500	1000	2000	4000	8000	Model	63	125	250	500	1000	2000	4000	8000
25-2T/H	38	48	65	65	73	69	62	53	56-6T/H	28	45	58	65	70	71	66	59
25-4T/H	25	35	52	52	60	56	49	40	63-4T/H	43	60	73	80	85	86	81	74
31-2T/H	46	56	73	73	81	77	70	61	63-6T/H	33	50	63	70	75	76	71	64
31-4T/H	28	38	55	55	63	59	52	43	71-4T/H	47	64	77	84	89	90	85	78
35-2T/H	50	60	77	77	85	81	74	65	71-6T/H	35	52	65	72	77	78	73	66
35-4T/H	32	42	59	59	67	63	56	47	80-4T/H	60	81	88	93	96	92	85	74
40-4T/H	28	45	57	65	70	70	66	59	80-6T/H	49	70	77	82	85	81	74	63
40-6T/H	20	37	49	57	62	62	58	51	90-4T/H	64	85	92	97	100	96	89	78
45-4T/H	33	50	63	70	75	76	71	64	90-6T/H	54	75	82	87	90	86	79	68
45-6T/H	24	41	54	61	66	67	62	55	100-4T/H	68	88	96	101	103	100	93	82
50-4T/H	36	53	66	73	78	79	74	67	100-6T/H	58	78	86	91	93	90	83	72
50-6T/H	26	43	56	63	68	69	64	57									
56-4T/H	39	56	69	76	81	82	77	70									

AXIAL FANS AND ROOF-MOUNTED EXTRACT FANS

Dimensions mm

HC-25...63

Model	A	B	ØC	ØD	E	G	H	ØJ	K
HC-25	330	275	262	260	241	11	56	8.5	310
HC-31-2	400	336	310.5	308	264.5	11	65	8.5	380
HC-31-4	400	336	310.5	308	245.5	11	65	8.5	380
HC-35-2	465	390	362.5	360	310	11	76	10.5	450
HC-35-4	465	390	362.5	360	261	11	76	10.5	450
HC-40-4.../H	532	452	412.5	410	332	11	97.5	10.5	500
HC-40-6.../H	532	452	412.5	410	332	11	97.5	10.5	500
HC-45-4.../H	596	504	462.5	460	339	11	105	10.5	560
HC-45-6.../H	596	504	462.5	460	339	11	105	10.5	560
HC-50-4T/H	665	562	516.5	514	376	11	115	10.5	640
HC-50-4M/H	665	562	516.5	514	376	11	115	10.5	640
HC-50-6.../H	665	562	516.5	514	336	11	115	10.5	640
HC-56-4T/H	710	630	563	560	374	15	115	10.5	721
HC-56-6.../H	710	630	563	560	351	15	115	10.5	721
HC-63-4T/H	800	710	638	635	399	15	140	10.5	820
HC-63-6.../H	800	710	638	635	376	15	140	10.5	820

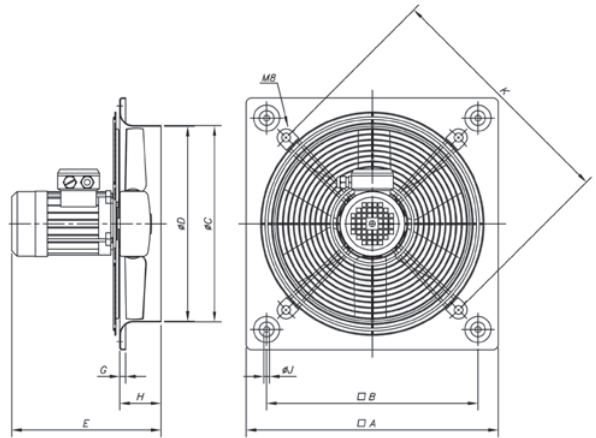

HC-71...100

Model	A	B	ØC	ØD	E	G	H	ØJ
HC-71-4T/H	850	810	714	710	395	20	150	14.5
HC-71-6T/H	850	810	714	710	395	20	150	14.5
HC-80-4T/H	970	910	804	800	500	20	180	14.5
HC-80-6T/H	970	910	804	800	458	20	180	14.5
HC-90-4T/H	1170	1110	904	900	511	20	180	14.5
HC-90-6T/H	1170	1110	904	900	500	20	180	14.5
HC-100-4T/H	1170	1110	1004	1000	548	20	180	14.5
HC-100-6T/H	1170	1110	1004	1000	498	20	180	14.5

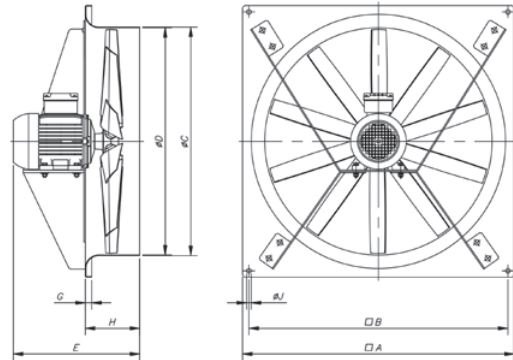

Characteristic curves

Q= Flow rate in m³/h, m³/s and cfm.

Pe= Static pressure in mm H₂O, Pa and inwg.

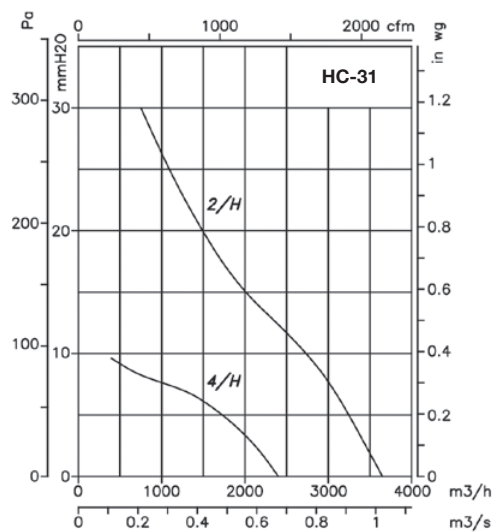
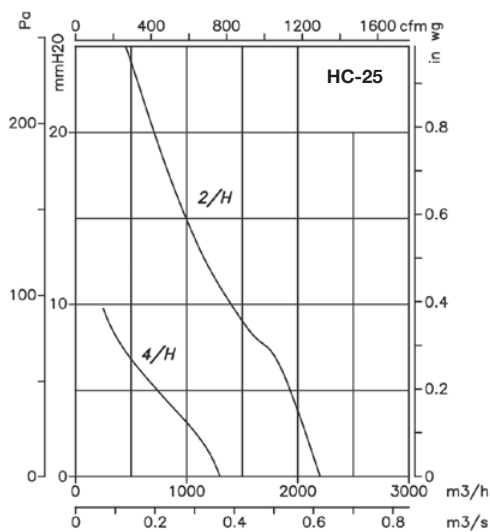

Characteristic curves

Q= Flow rate in m³/h, m³/s and cfm.

Pe= Static pressure in mm H₂O, Pa and inwg.

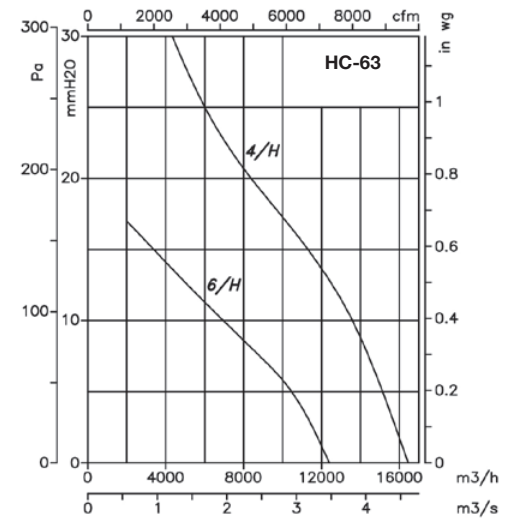
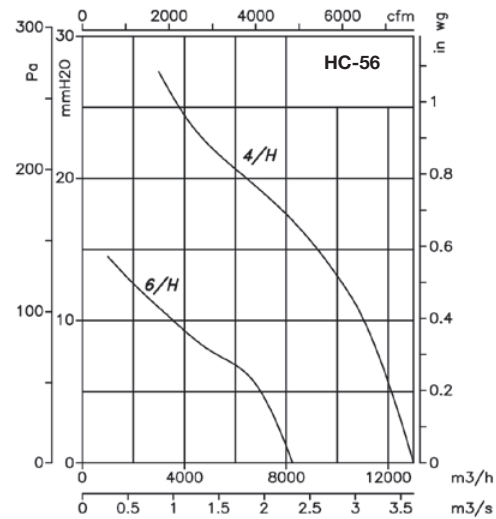
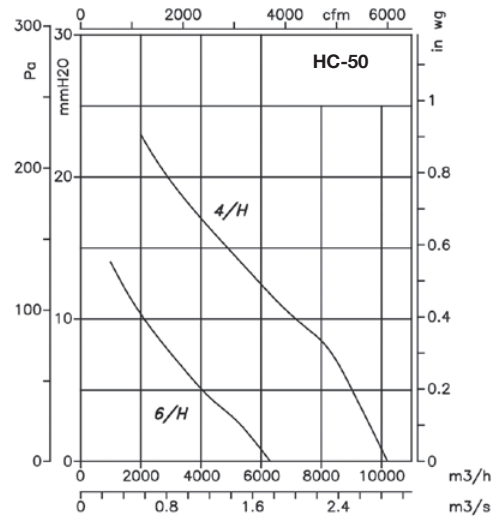
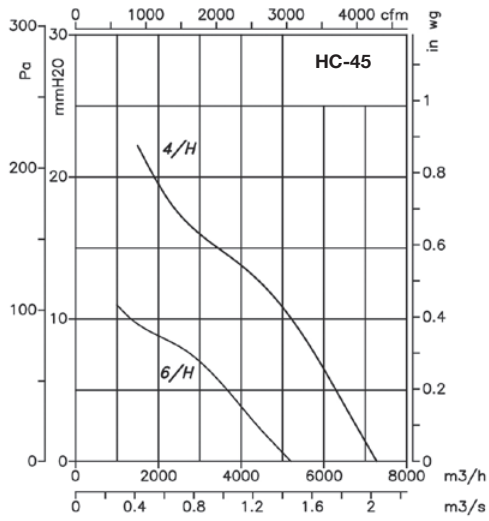
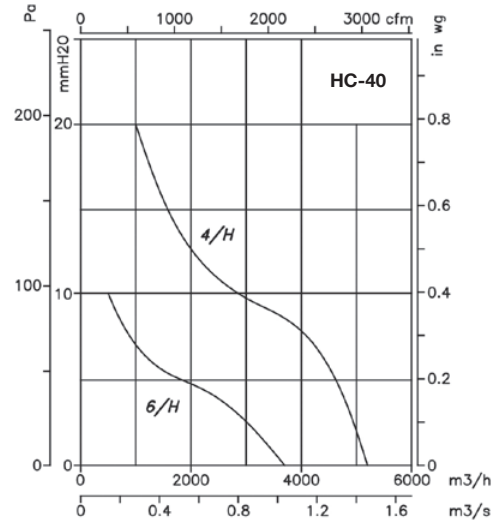
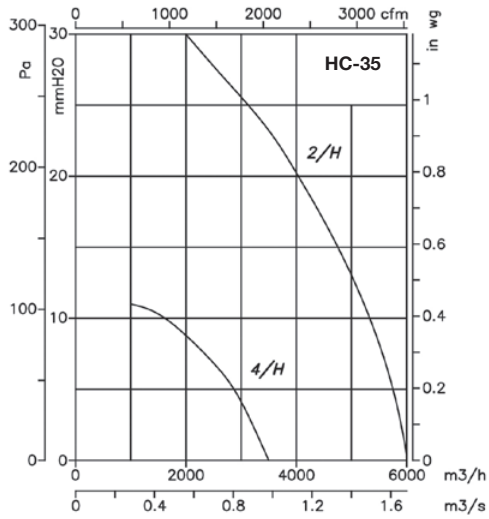

AXIAL FANS AND ROOF-MOUNTED EXTRACT FANS

Characteristic curves

Q= Flow rate in m³/h, m³/s and cfm.

Pe= Static pressure in mm H₂O, Pa and inwg.

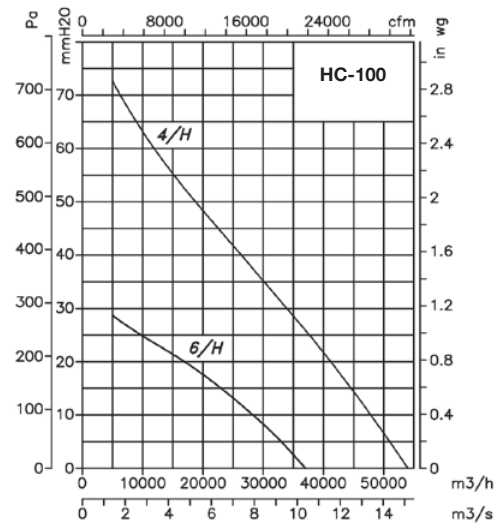
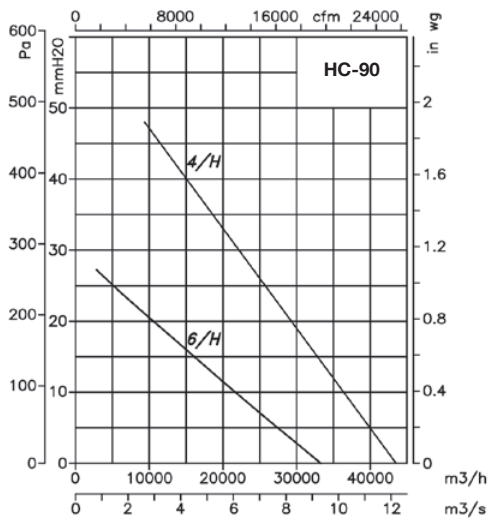
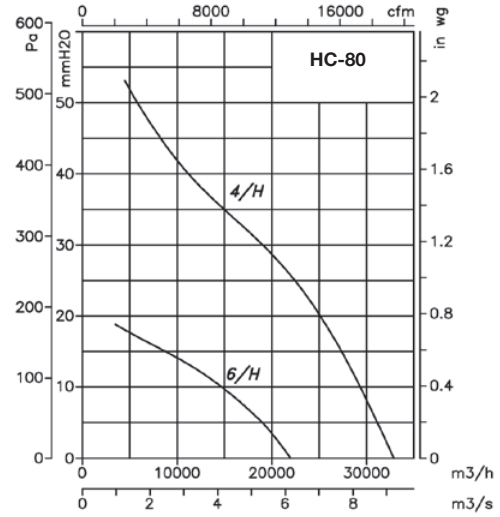
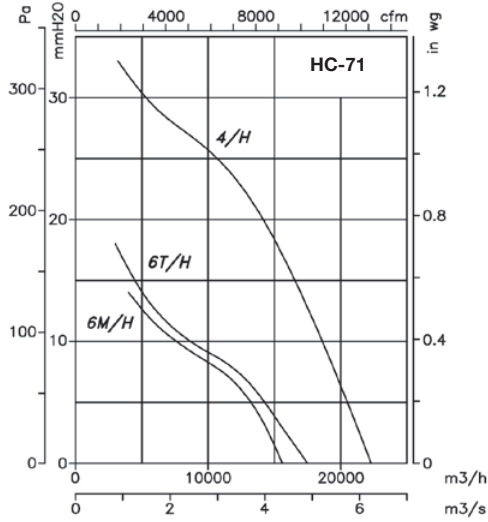

Accessories

See accessories section.

