

HFW/EC

Hot dip galvanized tubular axial fans, with EC Technology IE5 motor



EC TECHNOLOGY MOTOR with integrated electronics



EC CONTROL Supplied as an optional accessory

Hot-dip galvanized tubular axial fans, with EC Technology IE5 motor with integrated electronics, specially designed for high energy efficiency.

Fan:

- Airflow direction from motor to impeller.
- AL version rotors made of cast aluminium.
- Support ring in sheet steel with double flange and cable glands for motor supply.
- Hot dip galvanised tubular sheet steel casing.

Motor:

- High efficiency EC Technology motors with integrated electronics, regulated by 0-10 V or 4-20 mA.
- IE5 efficiency motors, class F and IP55 protection.
- Single-phase 230 V 50/60 Hz and three-phase 400 V 50/60 Hz.
- Working temperature: -25 °C +60 °C.

EC CONTROL: Supplied as an optional accessory. Control panel for ventilation systems with EC Technology motors with the electronics integrated in the motor itself. With the following characteristics:

- CPC: Constant pressure control.
- CFC: Constant flow control.
- DAY/NIGHT: Double pressure setpoint adjustment according to time of day.
- External sensor: compatible with temperature, humidity, air quality or CO sensor.
- Equipment preconfigured in constant pressure mode with 100 Pa set point.

Finish:

- Hot dip galvanized

On request:

- Airflow direction from impeller to motor.
- Fibreglass reinforced polyamide PL version impellers.
- 100% reversible impellers.

Order code

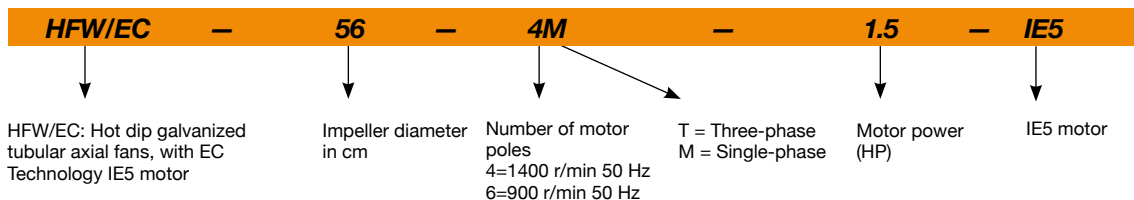

Technical characteristics

Model	Speed (r/min)	Maximum admissible current (A)		Max. electric power (kW)	Maximum flow rate (m³/h)	Sound pressure level dB (A)	Approx. weight (Kg)	According ErP*
		230V	400V					
HFW/EC-56-4M-1.5 IE5	1455	8.9		1.1	13600	74	34	2020
HFW/EC-63-4M-1.5 IE5	1455	8.9		1.1	17800	74	36	2020
HFW/EC-63-4T-3 IE5	1435		5.9	2.2	22150	76	44	2020
HFW/EC-71-4M-1.5 IE5	1455	8.9		1.1	19500	78	39	2020
HFW/EC-71-4T-3 IE5	1435		5.9	2.2	25100	81	48	2020
HFW/EC-80-4T-3 IE5	1435		5.9	2.2	25450	82	56	2020
HFW/EC-80-4T-5.5 IE5	1450		10.6	4.0	32750	84	64	2020
HFW/EC-80-6T-3 IE5	950		7.5	2.2	29950	74	63	2020
HFW/EC-90-4T-5.5 IE5	1450		10.6	4.0	38900	89	73	2020
HFW/EC-90-6T-2 IE5	950		2.9	1.5	28800	77	67	2020
HFW/EC-90-6T-3 IE5	950		7.5	2.2	34000	78	72	2020
HFW/EC-100-6T-3 IE5	950		7.5	2.2	37600	82	80	2020

* In accordance with the ErP 2020 draft



Erp. (Energy Related Products)

Information on Directive 2009/125/EC can be downloaded from the SODECA website or the QuickFan selector programme.

Acoustic characteristics

The indicated values are determined by measuring the pressure and sound power levels in dB(A) obtained in a free field at a distance equivalent to twice the size of the fan plus the impeller diameter, with a minimum of 1.5 m.

Sound power spectrum Lw(A) in dB(A) per Hz frequency band

	63	125	250	500	1000	2000	4000	8000
HFW/EC-56-4M-1.5	49	69	77	82	84	81	74	63
HFW/EC-63-4M-1.5	48	68	76	81	83	80	73	65
HFW/EC-63-4T-3	53	70	78	83	85	82	77	67
HFW/EC-71-4M-1.5	54	74	82	87	89	86	79	69
HFW/EC-71-4T-3	58	72	80	85	87	84	77	71
HFW/EC-80-4T-3	57	77	85	90	92	89	82	73
HFW/EC-80-4T-5.5	56	75	84	89	91	88	81	70
HFW/EC-80-6T-3	51	68	76	81	83	80	73	62
HFW/EC-90-4T-5.5	60	81	88	93	96	92	85	74
HFW/EC-90-6T-2	58	79	86	91	94	90	83	72
HFW/EC-90-6T-3	56	70	77	82	85	81	74	63
HFW/EC-100-6T-3	61	72	80	85	87	84	77	66

Dimensions mm

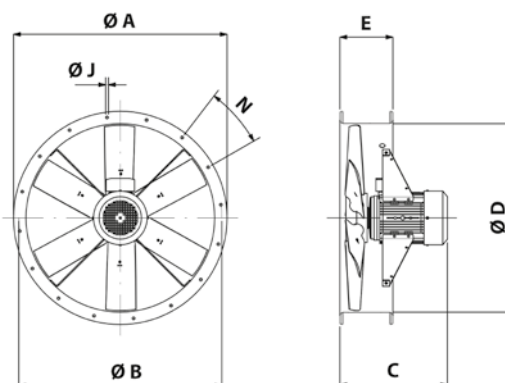

	ØA	ØB	C	ØD	E	N	ØJ
HFW/EC-56-4M-1.5	666	620	377	560	225	12X30°	12
HFW/EC-63-4M-1.5	735	690	389	640	225	12X30°	12
HFW/EC-63-4T-3	735	690	428	640	225	12X30°	12
HFW/EC-71-4M-1.5	815	770	360	710	225	12X30°	12
HFW/EC-71-4T-3	815	770	428	710	225	16x22°30'	12
HFW/EC-80-4T-3	905	860	436	800	225	16x22°30'	12
HFW/EC-80-4T-5.5	905	860	436	800	225	16x22°30'	12
HFW/EC-80-6T-3	905	860	436	800	225	16x22°30'	12
HFW/EC-90-4T-5.5	1020	970	445	900	225	16x22°30'	15
HFW/EC-90-6T-2	1020	970	445	900	225	16x22°30'	15
HFW/EC-90-6T-3	1020	970	445	900	225	16x22°30'	15
HFW/EC-100-6T-3	1118	1070	427	1000	225	16x22°30'	15

Accessories

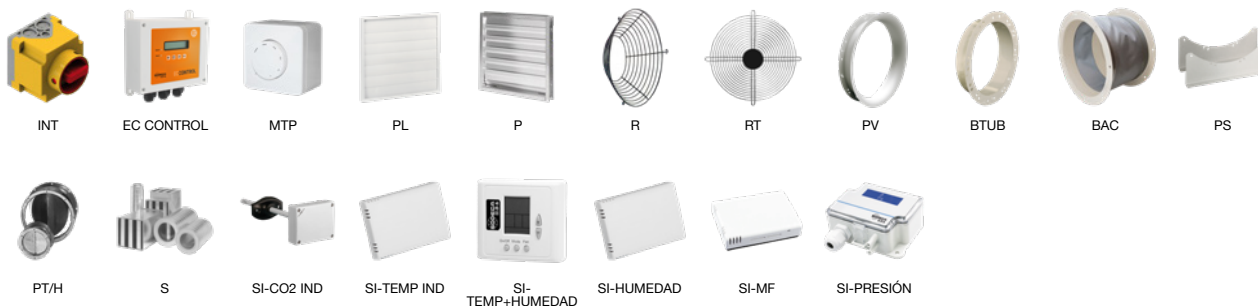

Characteristic curves

Q= Flow rate in m³/h, m³/s and cfm

Pe= Static pressure in mm H₂O, Pa and inwg

HFW/EC-56-4M-1.5

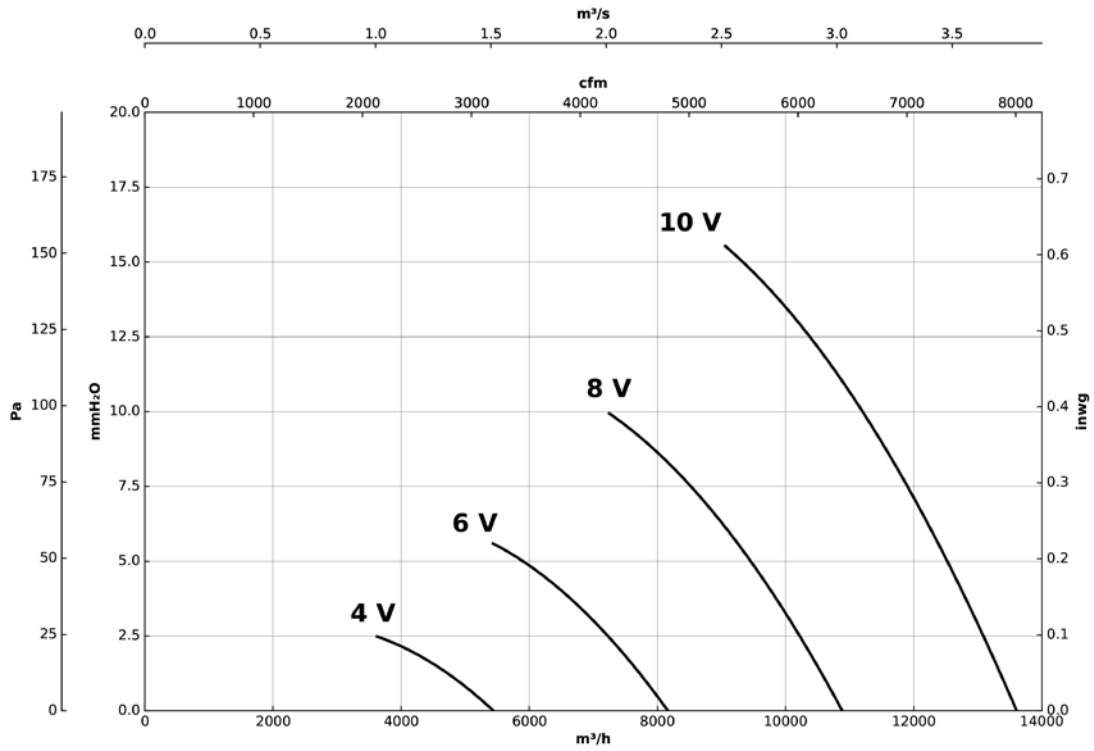

HFW/EC-63-4M-1.5

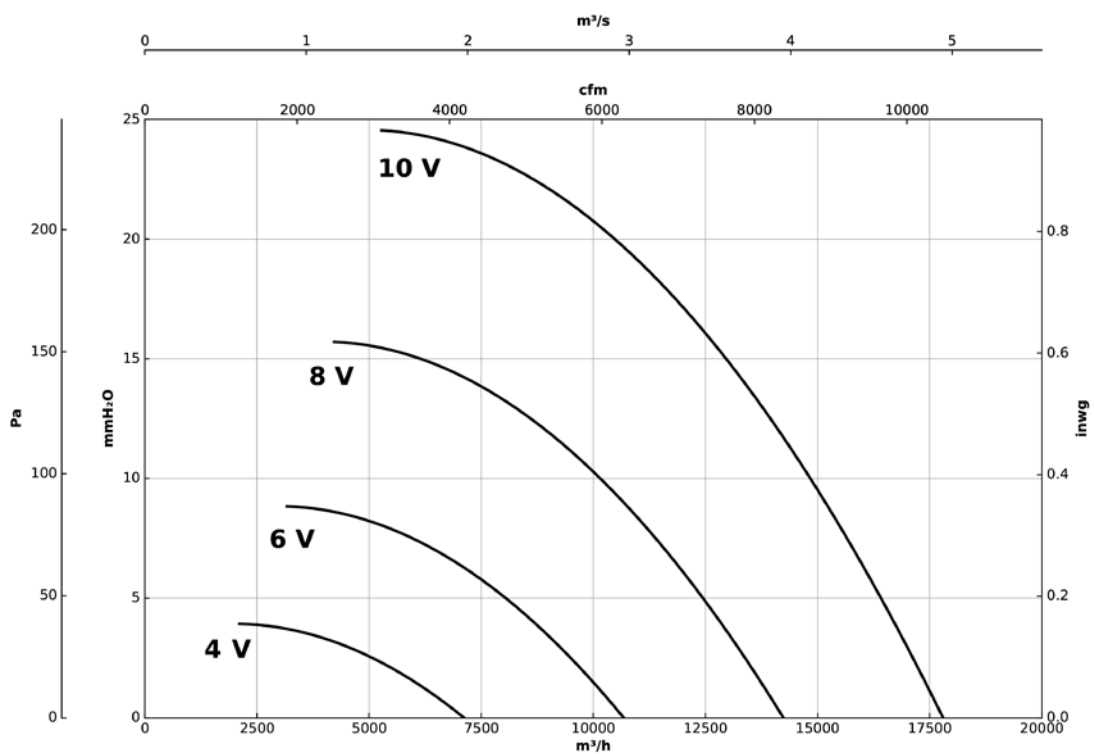

Characteristic curves

Q= Flow rate in m³/h, m³/s and cfm

Pe= Static pressure in mm H₂O, Pa and inwg

HFW/EC-63-4T-3

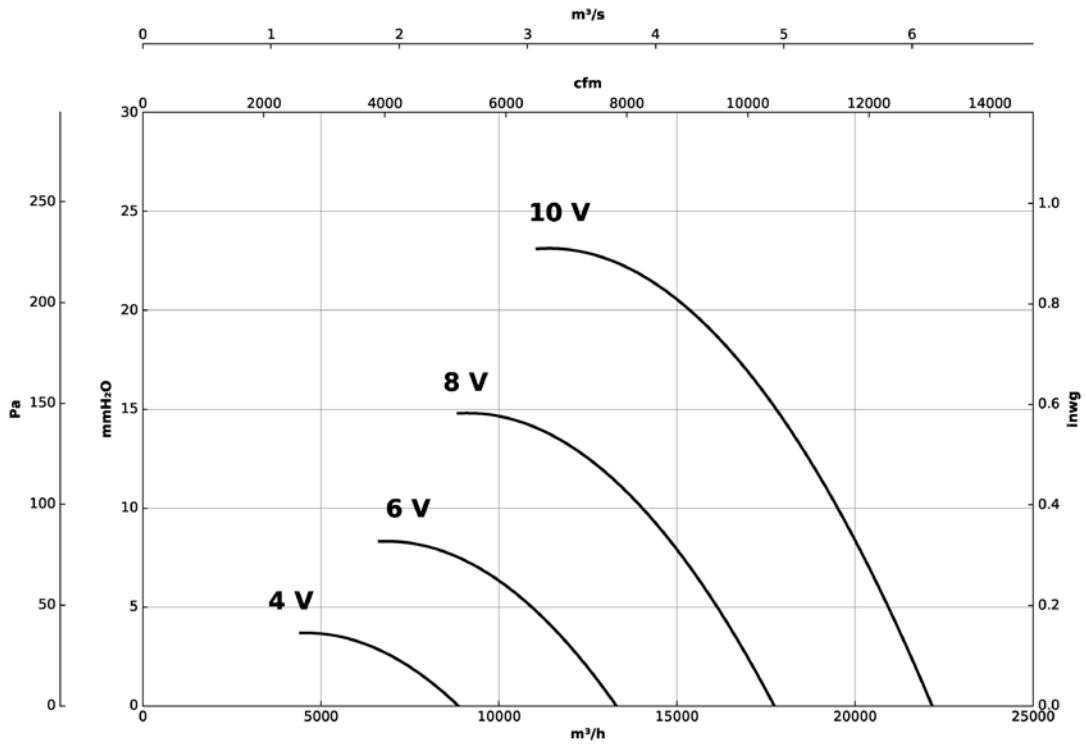

HFW/EC-71-4M-1.5

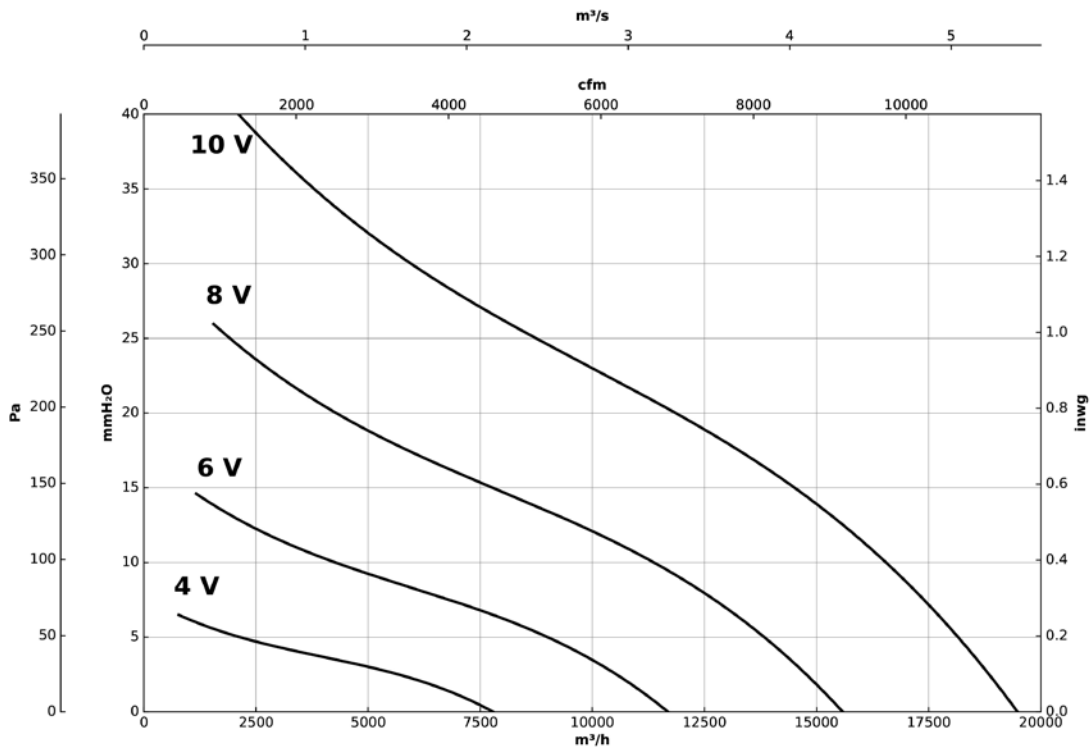

Characteristic curves

Q= Flow rate in m³/h, m³/s and cfm

Pe= Static pressure in mm H₂O, Pa and inwg

HFW/EC-71-4T-3

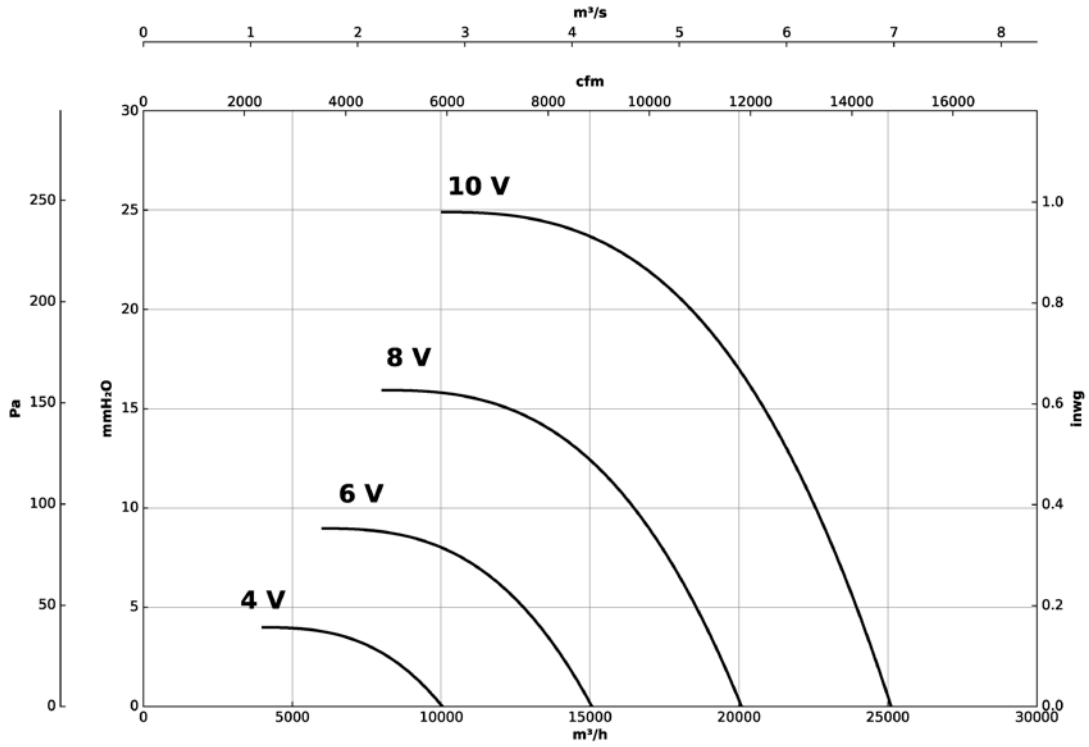

HFW/EC-80-4T-3

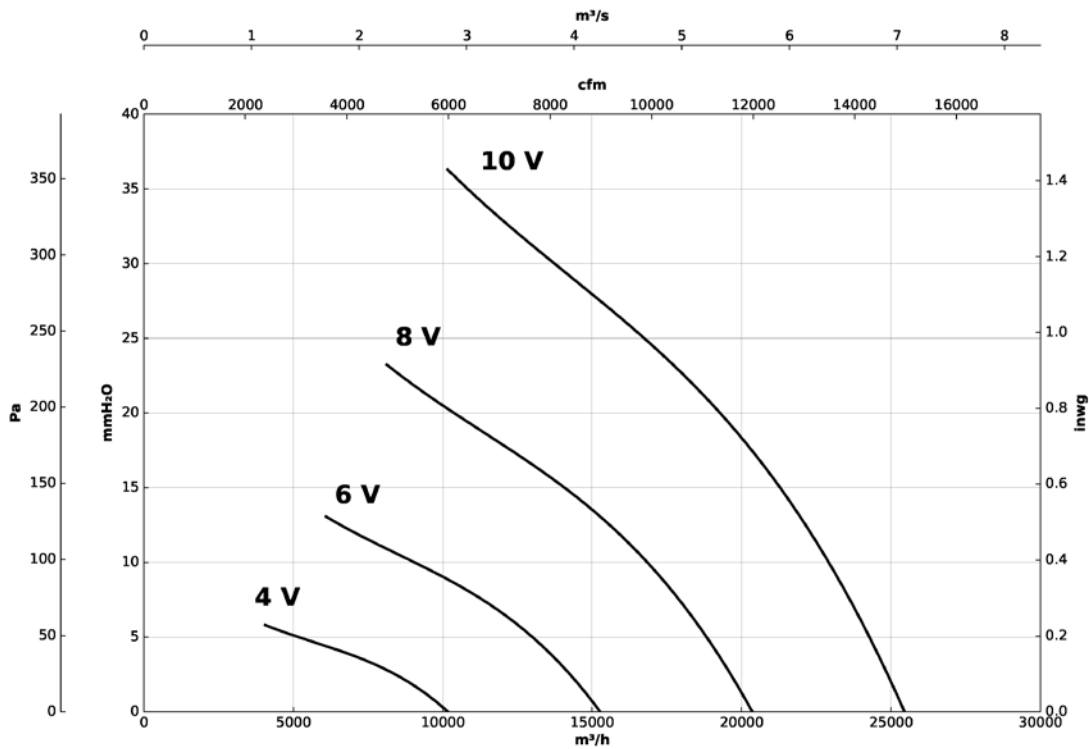

Characteristic curves

Q= Flow rate in m³/h, m³/s and cfm

Pe= Static pressure in mm H₂O, Pa and inwg

HFW/EC-80-4T-5.5

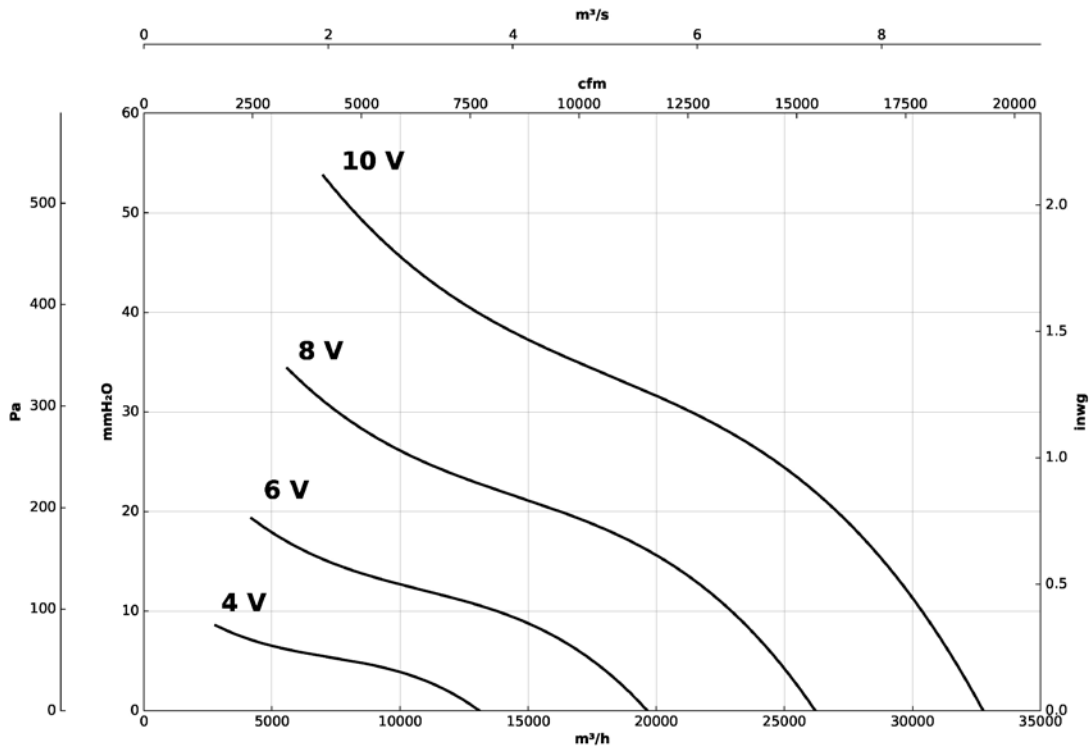

HFW/EC-80-6T-3

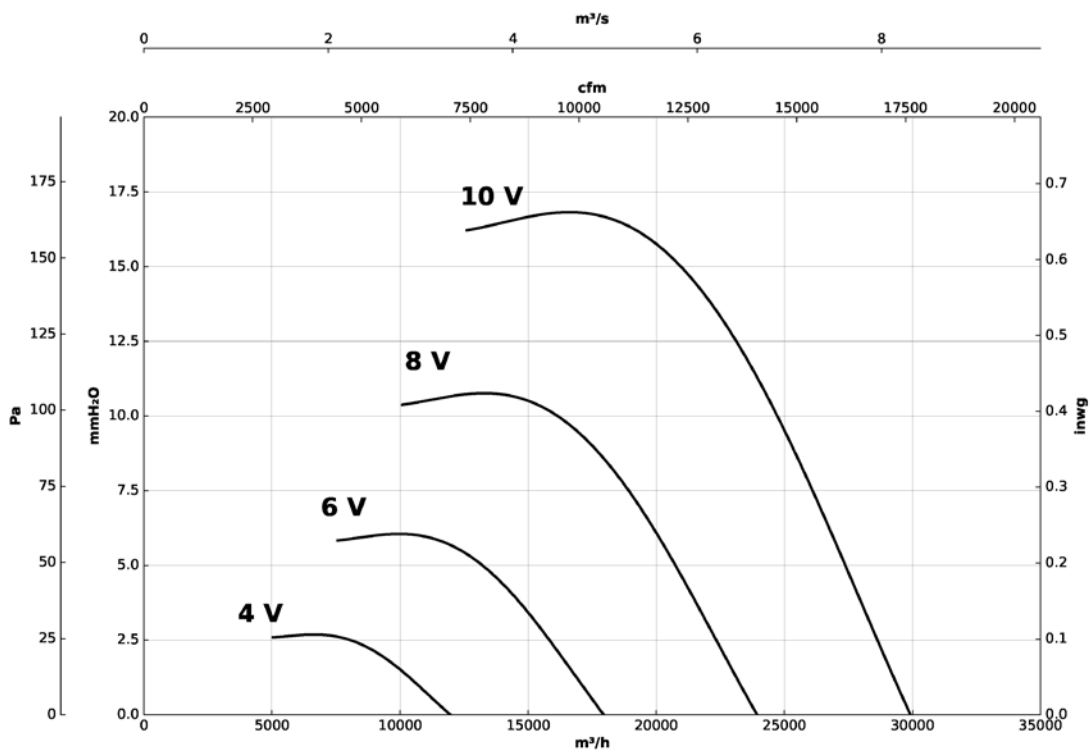

Characteristic curves

Q= Flow rate in m³/h, m³/s and cfm

Pe= Static pressure in mm H₂O, Pa and inwg

HFW/EC-90-4T-5.5

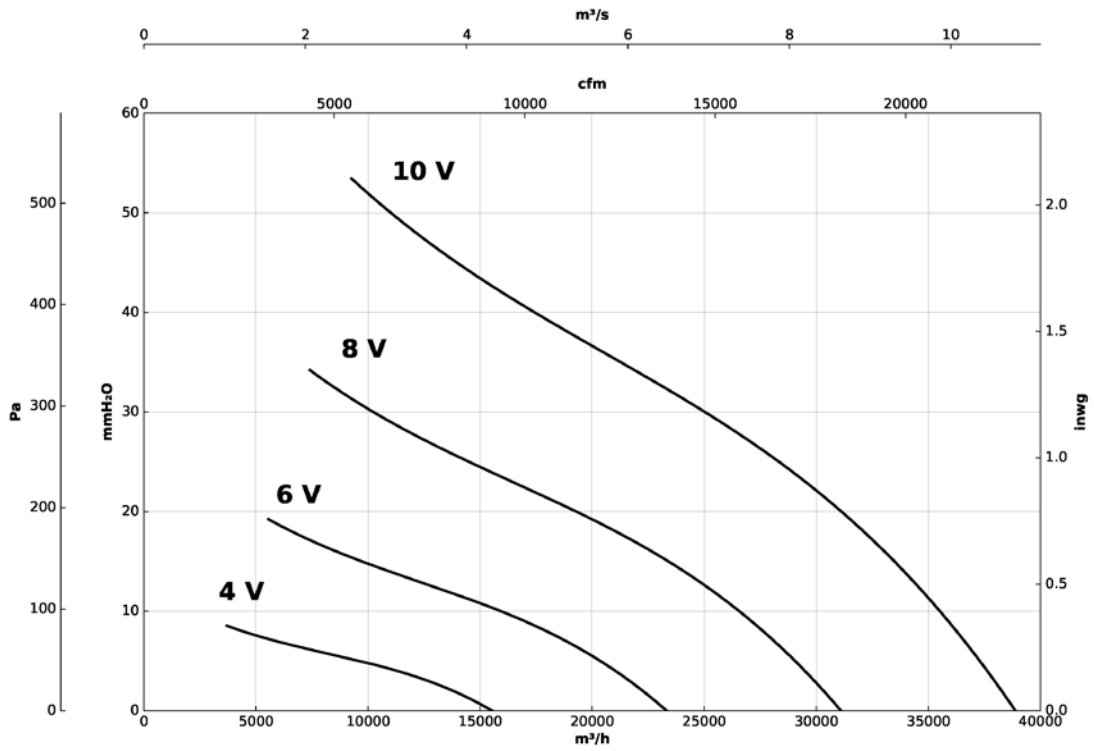

HFW/EC-90-6T-2

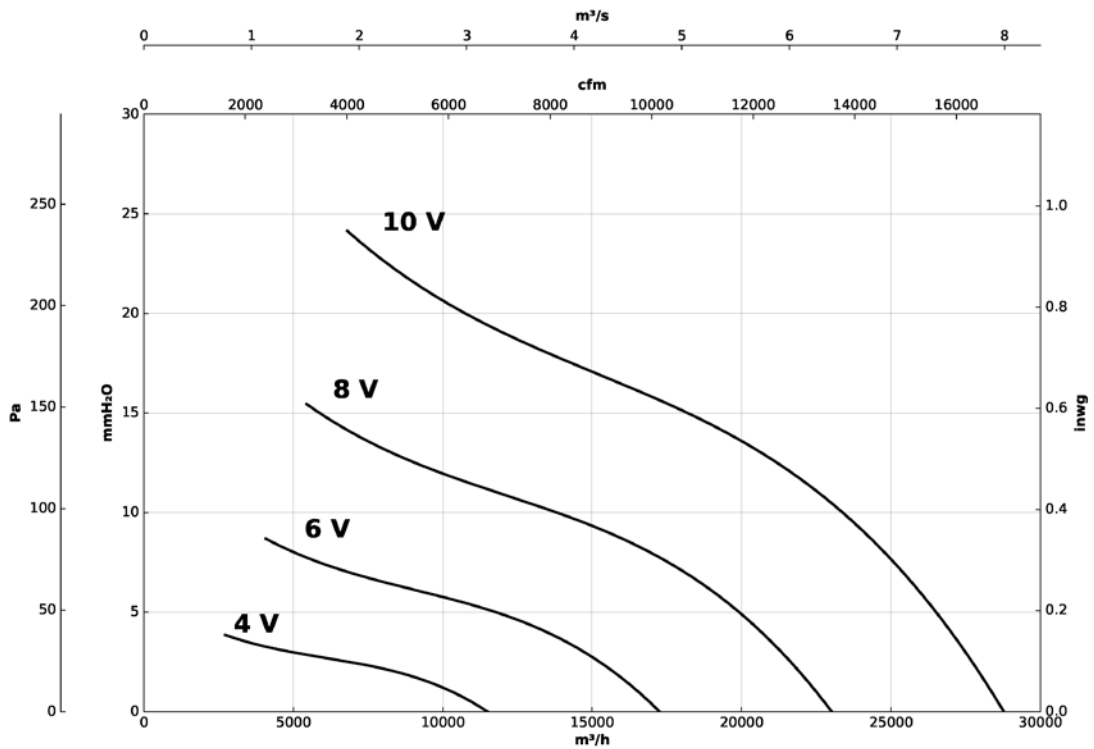

Characteristic curves

Q= Flow rate in m³/h, m³/s and cfm

Pe= Static pressure in mm H₂O, Pa and inwg

HFW/EC-90-6T-3

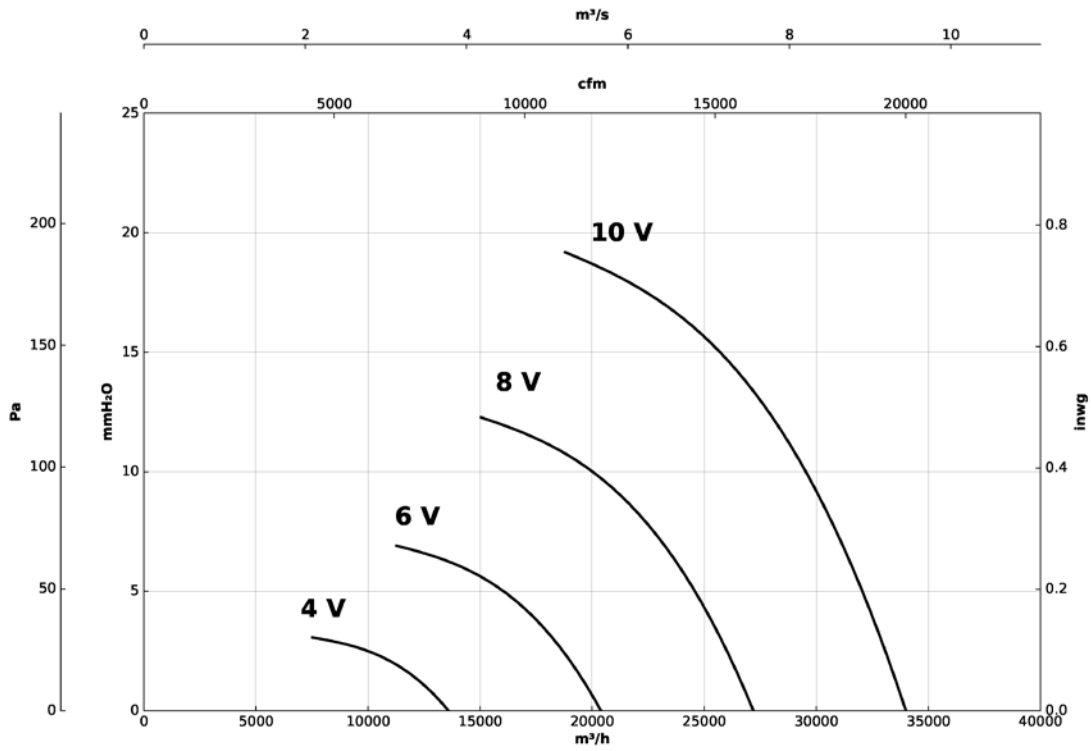

HFW/EC-100-6T-3

