

# TCR

400 °C/2h ja 300 °C/2h savunpoistokeskipakopuhaltimet taaksepäin kaartuva siipisellä siipipyörällä

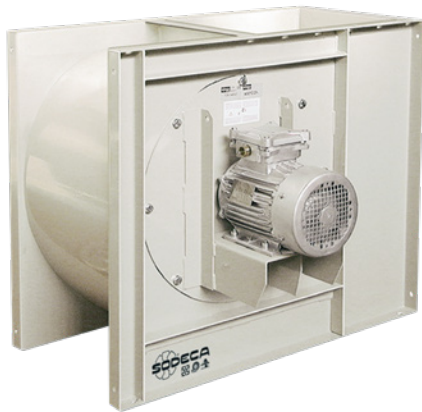

Vahvarakenteiset, yhdeltä puolelta imevät 400 °C/2h savunpoistokeskipakopuhaltimet. Voidaan sijoittaa palotilaan.

Puhallin:

- Kaapu terästä.
- Vahvarakenteinen teräksinen taaksepäin kaartuva siipinen siipipyörä kuumankestomaalauksella.
- Sertifioitu standardin EN 12101-3 mukaisesti, sertifikaattinumero: 0370-CPR-0384.

Moottori:

- IE3-hyötysuhdeluokka alkaen 0,75 kW moottoritehosta, pois lukien 2-nopeuksiset ja 8-napaiset moottorit.

- H-eristysluokan moottorit S1 jatkuvaan käyttöön ja S2 lyhytaikaiseen käyttöön tulipalotilanteessa. Kuulalaakereilla ja IP55-suojausluokalla.
- Kolmivaiheinen 230/400 V 50 Hz (3 kW moottoritehoon asti), tai 400/690 V 50 Hz (yli 3 kW moottoritehoilla).
- Kuljetettavan ilman lämpötila: Ilmanvaihtokäytössä (S1): -25 °C... +120 °C. Savunpoistokäytössä (S2): maks. 300 °C/2h tai 400 °C/2h.

Pintakäsittely:

- Polyesterijauhemaalaus. Pohjakäsittelynä rasvanpoisto fosfaatitonta nanoteknologiaa käyttäen.

## Tilaukoodi

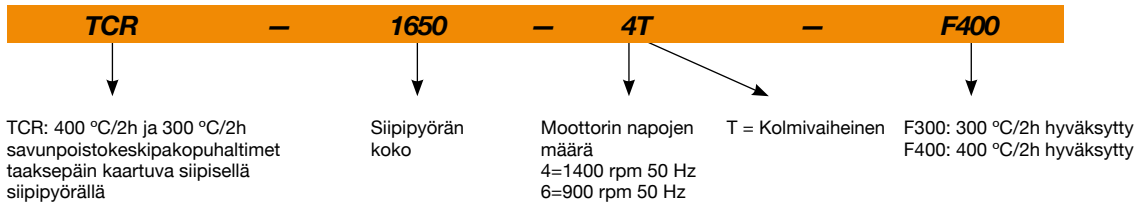

## Suuntaus

Vakiopuhallussuunta LG 270

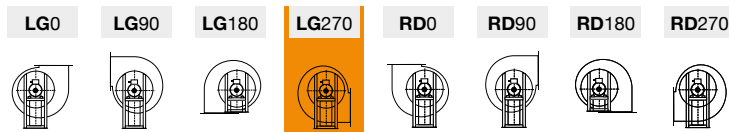

## Tekniset ominaisuudet

Malli	Pyörimisnopeus (rpm)	Nimellisvirta (A)			Moottoriteho (kW)	Maks. ilmamäärä (m³/h)	Äänenpainetaso¹ dB (A)	Paino noin (Kg)
		230V	400V	690V				
TCR-1240-4T IE3	1425	3,08	1,79		0,75	5830	65	76
TCR-1445-4T IE3	1435	4,10	2,37		1,10	8100	68	98
TCR-1650-4T IE3	1140	5,89	3,38		1,50	10600	70	118
TCR-1650-6T IE3	950	3,36	1,93		0,75	7410	60	118
TCR-1856-4T IE3	1455	11,01	6,33		3,00	15240	76	158
TCR-1856-6T IE3	950	4,73	2,72		1,10	10050	68	150
TCR-2063-4T IE3	1465		10,40	6,04	5,50	24490	78	257
TCR-2063-6T IE3	955	6,25	3,62		1,50	16100	68	212
TCR-2271-4T IE3	1480		20,70	11,99	11,00	34760	84	380
TCR-2271-6T IE3	970	12,80	6,36		3,00	23010	75	313

¹ Äänenpainetaso dB (A) 3 m etäisyydellä.

**Äänitiedot**

Heijastavan äänen tehon spektri Lw(A) asteikolla dB(A) / Hz-taajuuskaista

	63	125	250	500	1000	2000	4000	8000		63	125	250	500	1000	2000	4000	8000
TCR-1240-4T	53	67	73	76	76	77	67	56	TCR-1856-6T	58	66	78	80	77	78	68	57
TCR-1445-4T	56	69	75	80	77	80	75	61	TCR-2063-4T	77	82	88	90	88	85	78	70
TCR-1650-4T	61	71	79	81	80	82	73	63	TCR-2063-6T	66	67	79	79	78	80	70	60
TCR-1650-6T	50	62	69	74	70	66	59	51	TCR-2271-4T	80	81	90	93	95	96	92	79
TCR-1856-4T	66	75	88	84	87	88	82	68	TCR-2271-6T	70	70	84	83	87	87	76	65

**Mitat mm**

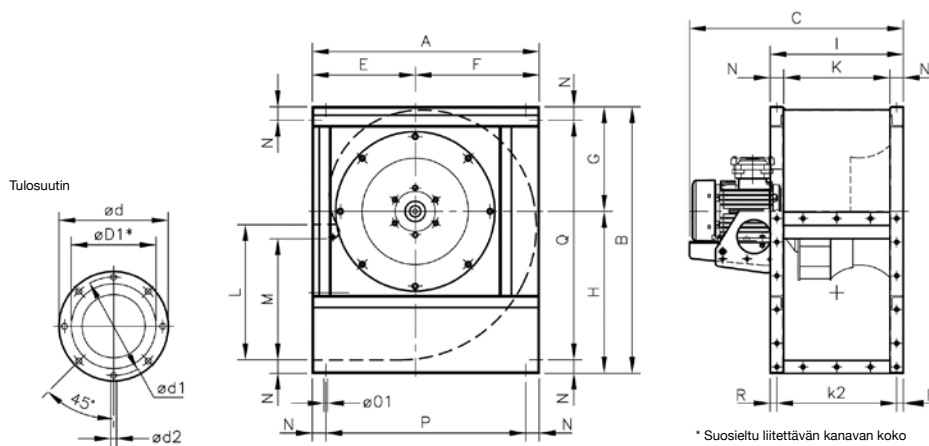

	A	B	C	Ød	Ød1	ØD1*	Ød2	E	F	G	H	M	N	Ø01	P	Q	R
TCR-1240-4T	673	790	634	472	444	400	M8	305	368	310	480	358,5	40	11	593	710	20
TCR-1445-4T	765	880	727	522	494	450	M8	350	415	339	541	407	45	11	675	790	20
TCR-1650-4T	832	970	770,5	582	555	500	M10	375	457	378	592	445	45	13	742	880	20
TCR-1650-6T	832	970	770,5	582	555	500	M10	375	457	378	592	445	45	13	742	880	20
TCR-1856-4T	925	1084	857,5	645	615	560	M10	415	510	424	660	493	50	13	825	984	25
TCR-1856-6T	925	1084	828	645	615	560	M10	415	510	424	660	493	50	13	825	984	25
TCR-2063-4T	1037	1218	955	720	688	630	M10	465	572	477	741	530	60	13	917	1098	30
TCR-2063-6T	1037	1218	932	720	688	630	M10	465	572	477	741	530	60	13	917	1098	30
TCR-2271-4T	1173	1375	1149	800	768	710	M12	525	648	538	837	603,5	65	13	1043	1245	32,5
TCR-2271-6T	1173	1375	1112	800	768	710	M12	525	648	538	837	603,5	65	13	1043	1245	32,5

Poistosuutin

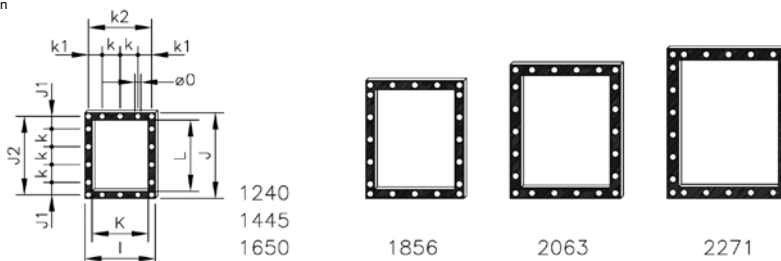

	I	J	J1	J2	K	k	k1	k2	L	Ø0
TCR-1240	395	480	70	440	315	100	77,5	355	400	11
TCR-1445	445	540	99	498	355	100	102,5	405	450	11
TCR-1650	490	590	87,5	550	400	125	100	450	500	13
TCR-1856	550	660	55	610	450	125	125	500	560	13
TCR-2063	620	750	95	690	500	125	92,5	560	630	13
TCR-2271	690	840	75	775	560	125	62,5	625	710	13

## Ominaiskäyrät

Q= Ilmamäärä m<sup>3</sup>/h, m<sup>3</sup>/s ja cfm

Pe= Staattinen paine mmH<sub>2</sub>O, Pa ja inwg

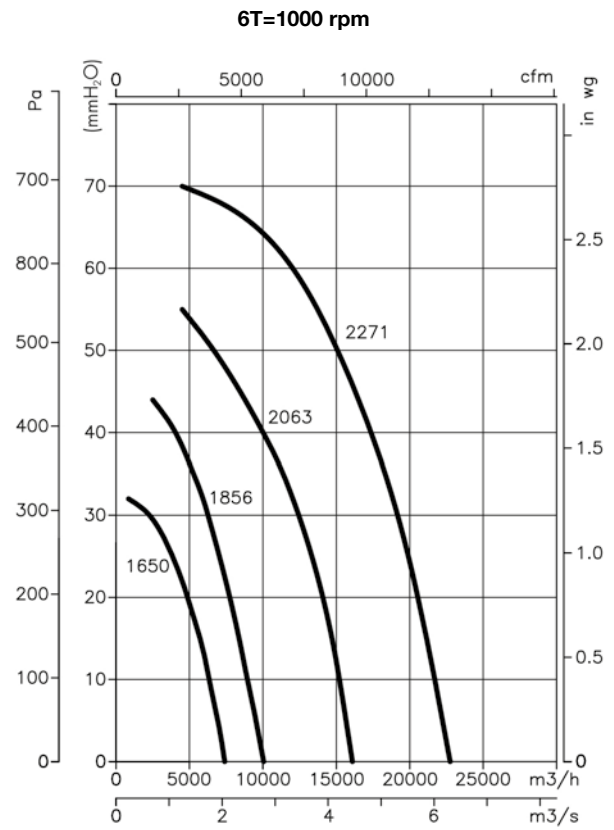
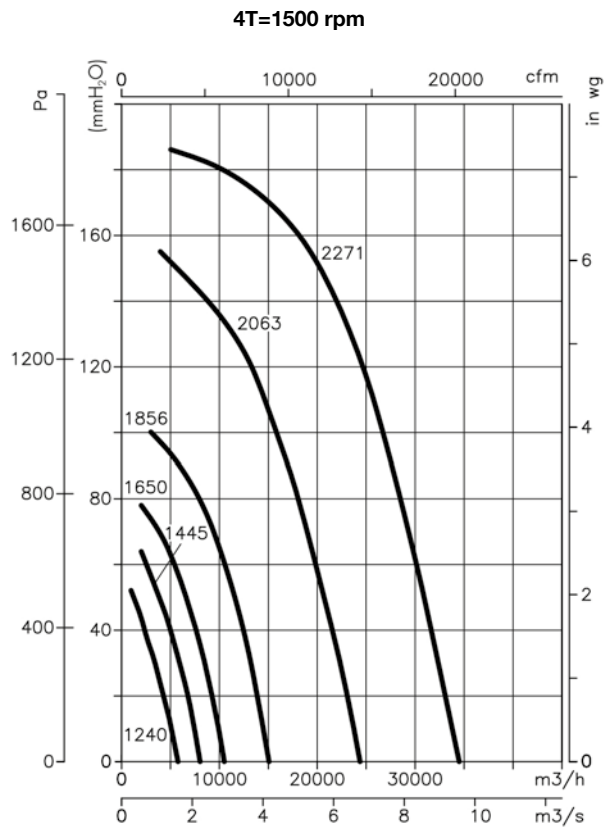

## Lisävarusteet



INT



IAT



C2V



RPA



B



BD



BIC



ACE ACE/400



CABLE BOX



AET



CENTRAL CO



VSD3/A-RFT  
- VSD1/A-RFM