

CSXR



Ventilatore centrifugo a doppia aspirazione preparato per trasmissione in un lato dell'asse con girante a reazione



Ventilatore:

- Rivestimento in lamiera di acciaio galvanizzato.
- Girante con pale rovesce in lamiera di acciaio verniciato.
- Temperatura massima dell'aria da movimentare: -25 °C +85 °C.

Finitura:

- Lamiera di acciaio galvanizzato.

Su richiesta:

- Certificazione ATEX.

Esempio di codice per ordine

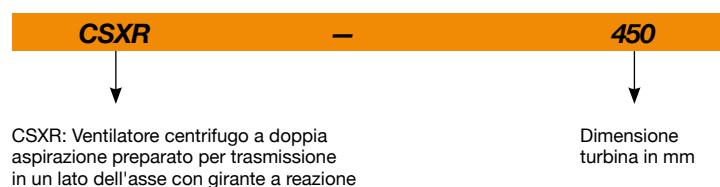

Caratteristiche tecniche

Modello	Velocità max.	Potenza installata max.	Portata massima (m ³ /h)	Temperatura dell'aria (°C)		Peso circa (Kg)
	(giri/min)	(kW)		min.	max.	
CSXR-315	3380	1,1	5540	-25	+85	27
CSXR-355	3100	1,5	7240	-25	+85	39
CSXR-400	2610	1,5	8650	-25	+85	44
CSXR-450	2700	3,0	12440	-25	+85	55
CSXR-500	2300	5,5	13630	-25	+85	70
CSXR-560	2000	7,5	17850	-25	+85	110
CSXR-630	1900	7,5	22800	-25	+85	125
CSXR-710	1750	7,5	31120	-25	+85	175
CSXR-800	1600	22,0	41050	-25	+85	252
CSXR-900	1400	30,0	46380	-25	+85	360
CSXR-1000	1400	37,0	56020	-25	+85	445



Erp. (Energy Related Products)

Informazioni sulla direttiva 2009/125/CE scaricabili dal sito web di SODECA o da QuickFan Selector.

Dimensioni in mm

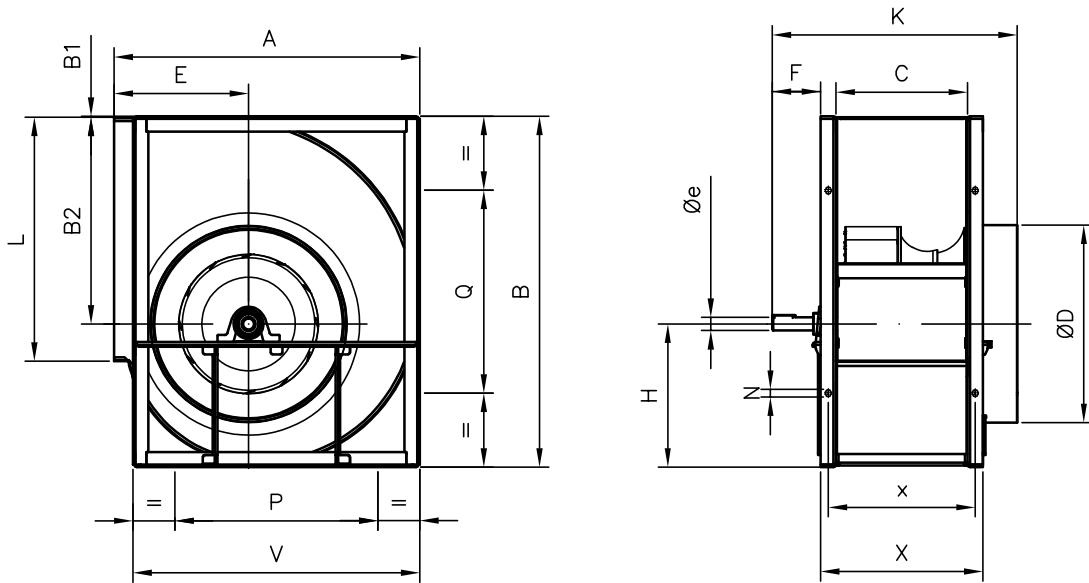

	A	B	B1	B2	C	øD	øe	E	F	H	K	L	N	P	Q	V	X	x
CSXR-315	518	578	2	404	223	322	25	236	83	235	441	404	13x18	280	280	480	283	253
CSXR-355	578	655	-	385	247	362	35	261	78	266	483	453	13x18	355	355	548	327	287
CSXR-400	651	733	-	433	274	420	35	290	91	300	520	507	13x18	355	355	613	354	314
CSXR-450	726	823	-	487	308	470	35	322	126,6	336	604,6	569	13x18	530	530	681	388	348
CSXR-500	800	918	3	543	344	517	35	352	126,6	375	640,6	638	15x20	530	530	750	424	384

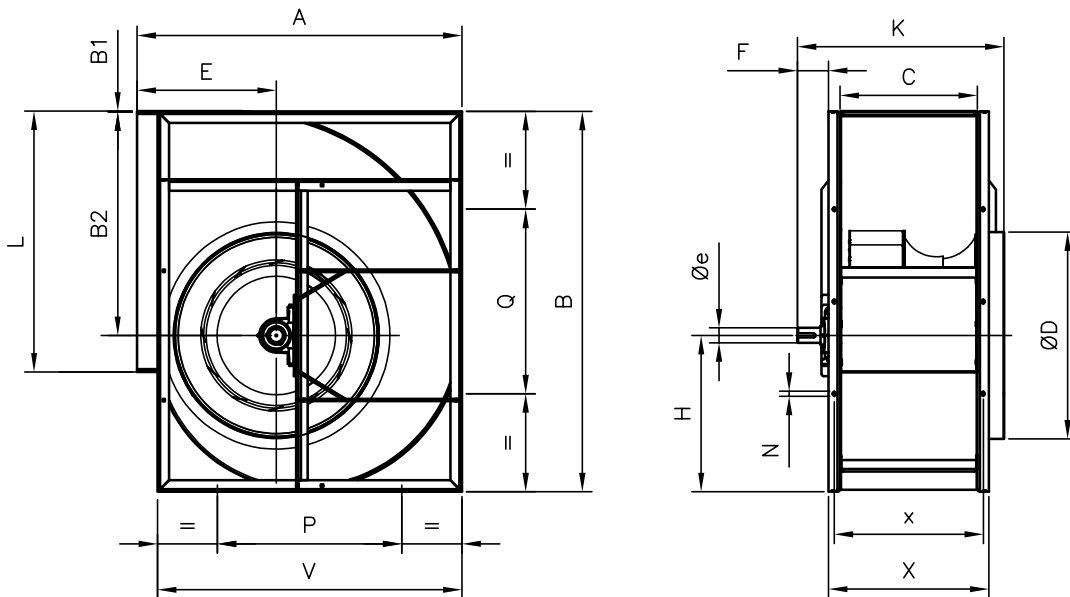

	A	B	B1	B2	C	øD	øe	E	F	H	K	L	N	P	Q	V	X	x
CSXR-560	893	1030	-	605	383	570	40	390	87	420	662,7	715	13x18	530	530	845	483	433
CSXR-630	999	1157	-	681	432	635	45	434	87	471,5	718	801	13x18	530	530	946	532	482
CSXR-710	1121	1303	-	766	478	722	50	485	115	531	800,3	898	17x22	630	630	1058	578	528
CSXR-800	1250	1468	-	862	533	808	65	535	126	606	840,5	1008	17x22	705	705	1181	633	583
CSXR-900	1408	1649	1	971	595	896	65	604	135	677	911,5	1130	17x22	550	550	1319	695	645
CSXR-1000	1501	1810	1	1066	663	996	65	617	135	744	979,5	1267	17x22	895	895	1462	763	713

Curve caratteristiche

Q= Portata in m³/h, m³/s e cfm

Pe= Pressione statica in mmH₂O, Pa e inWG

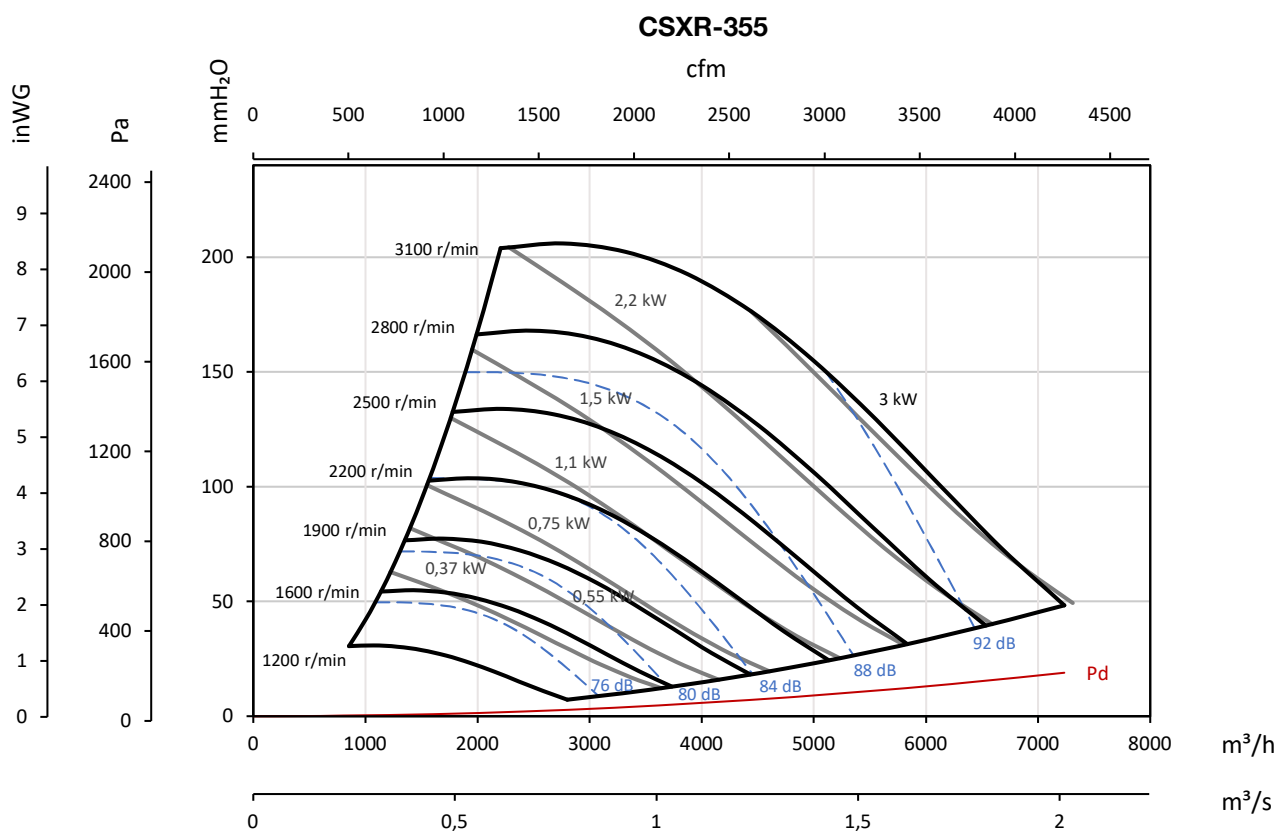
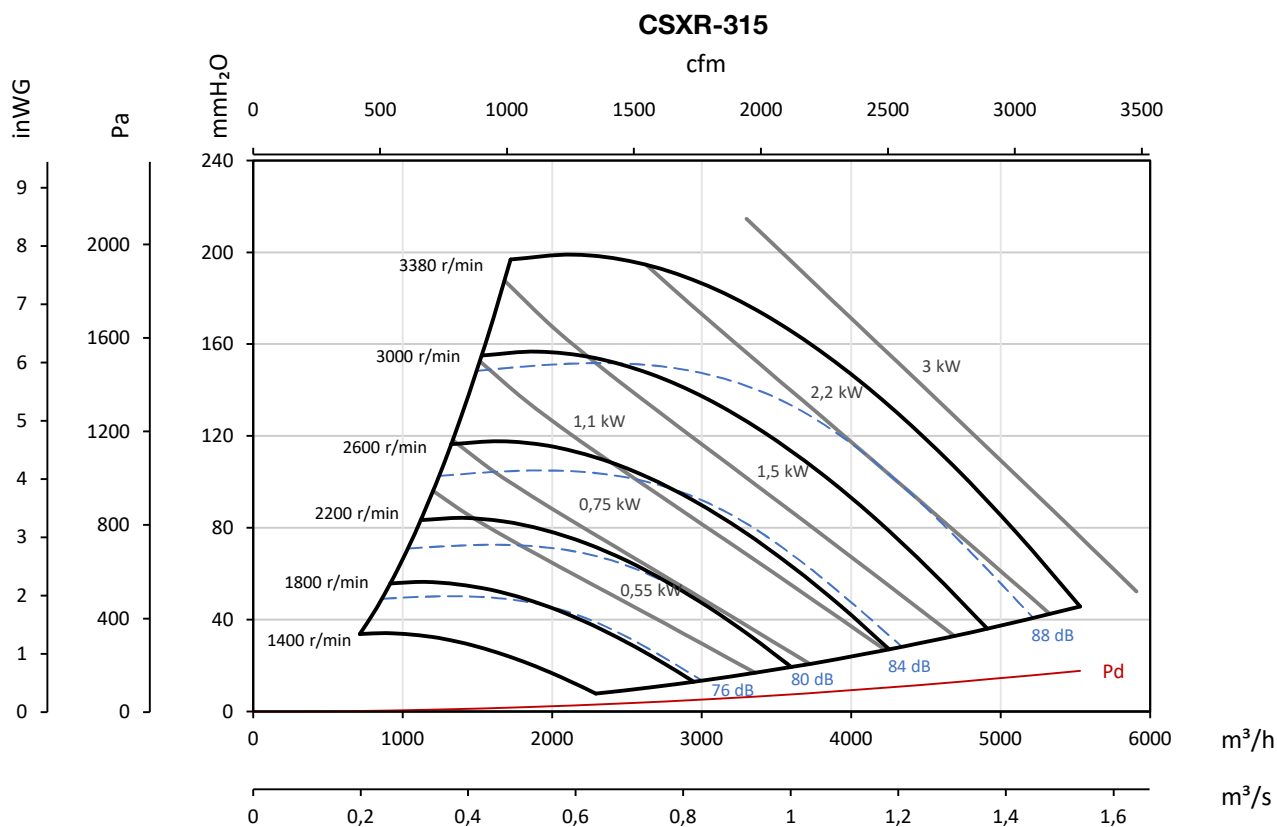

Curve caratteristiche

Q= Portata in m³/h, m³/s e cfm

Pe= Pressione statica in mmH₂O, Pa e inWG

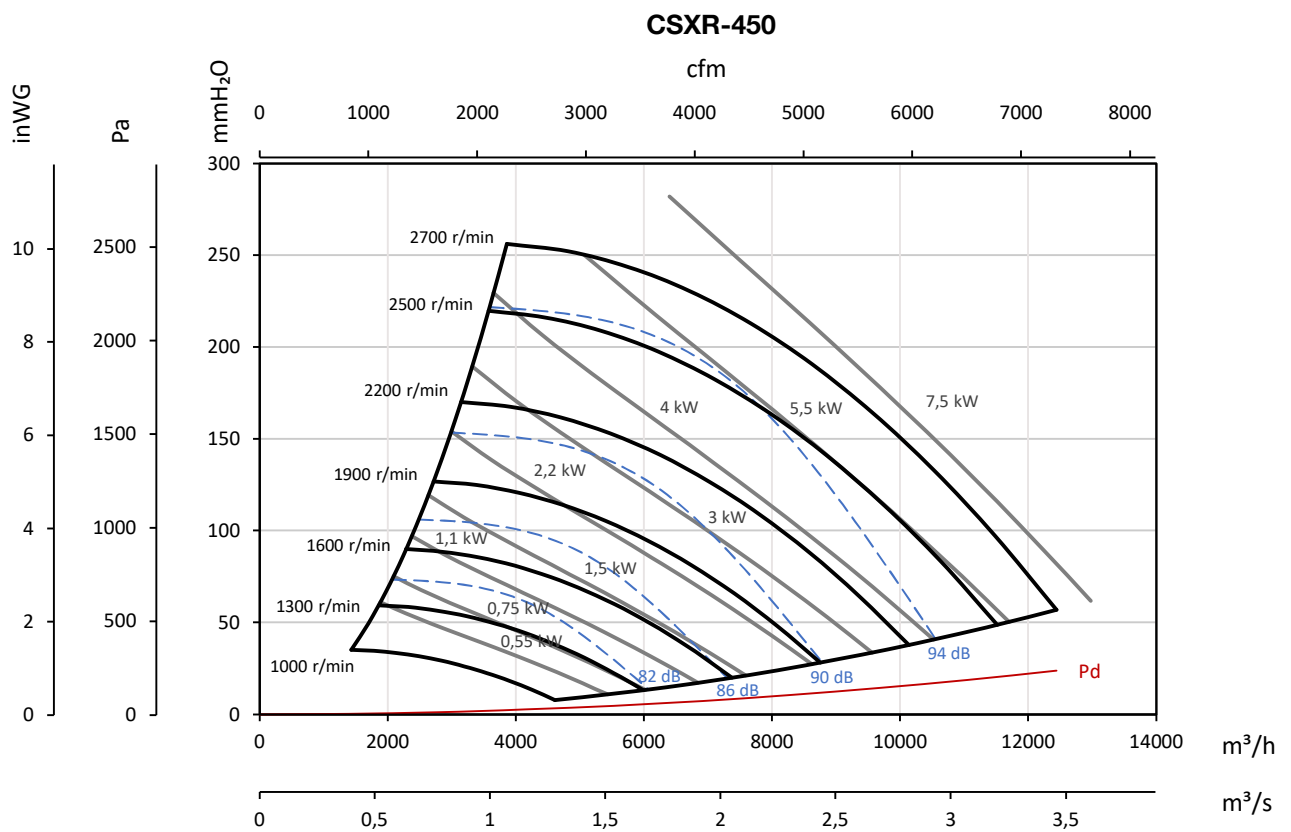
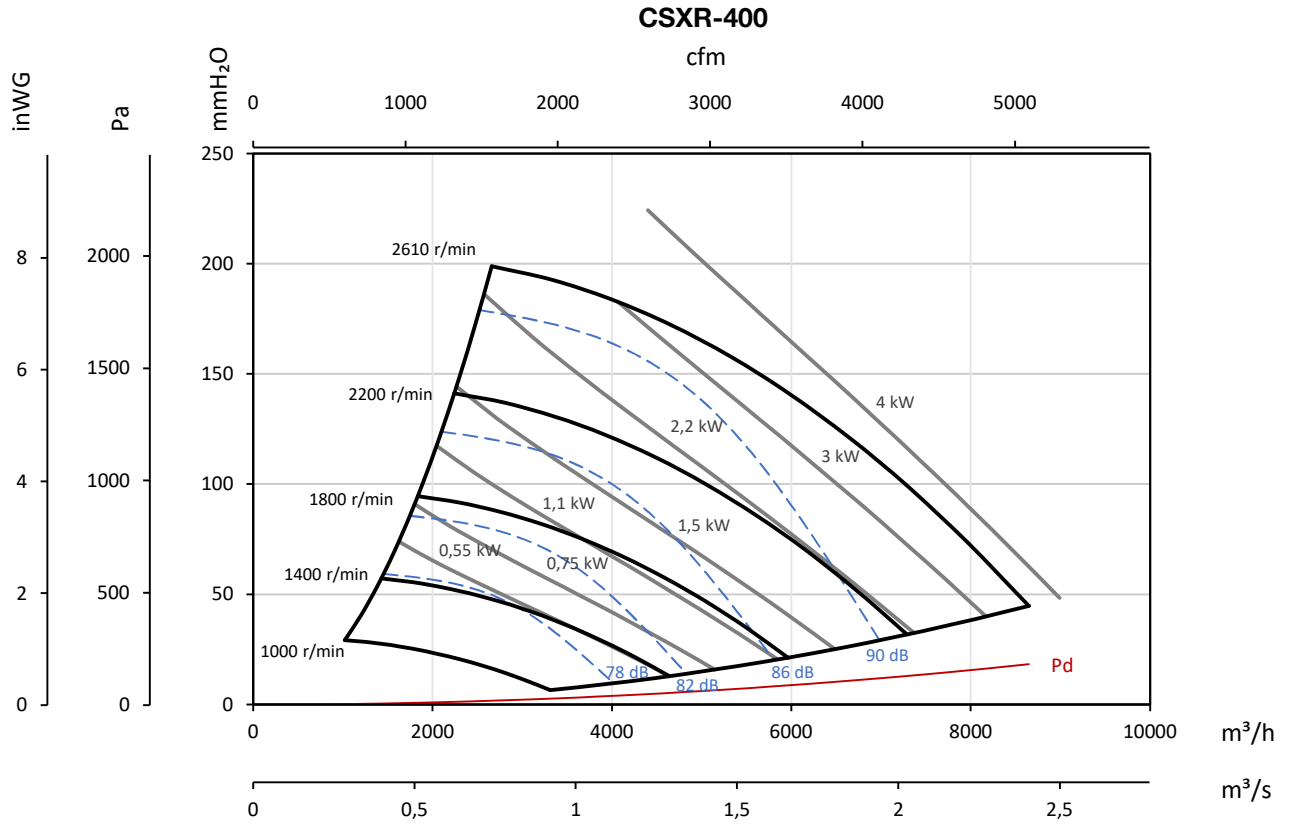

Curve caratteristiche

Q= Portata in m³/h, m³/s e cfm

Pe= Pressione statica in mmH₂O, Pa e inwg

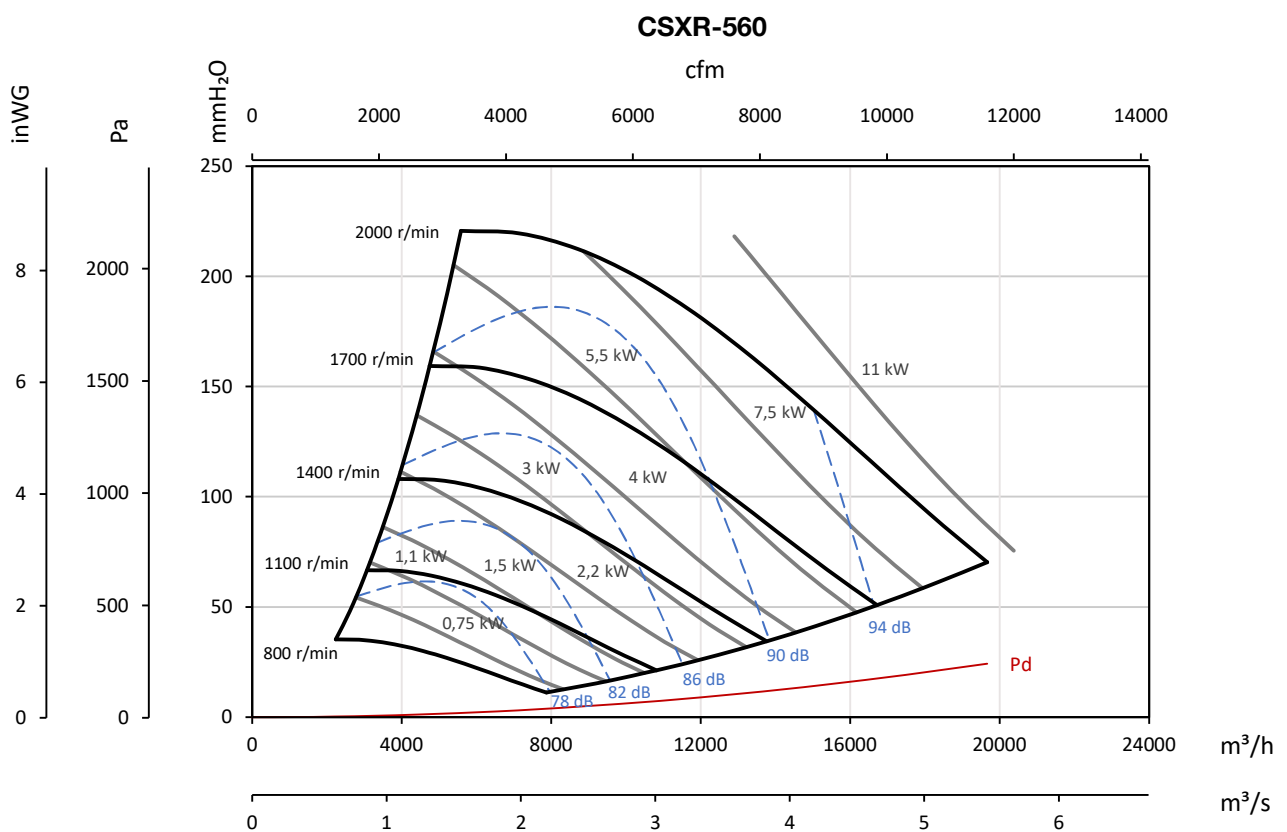
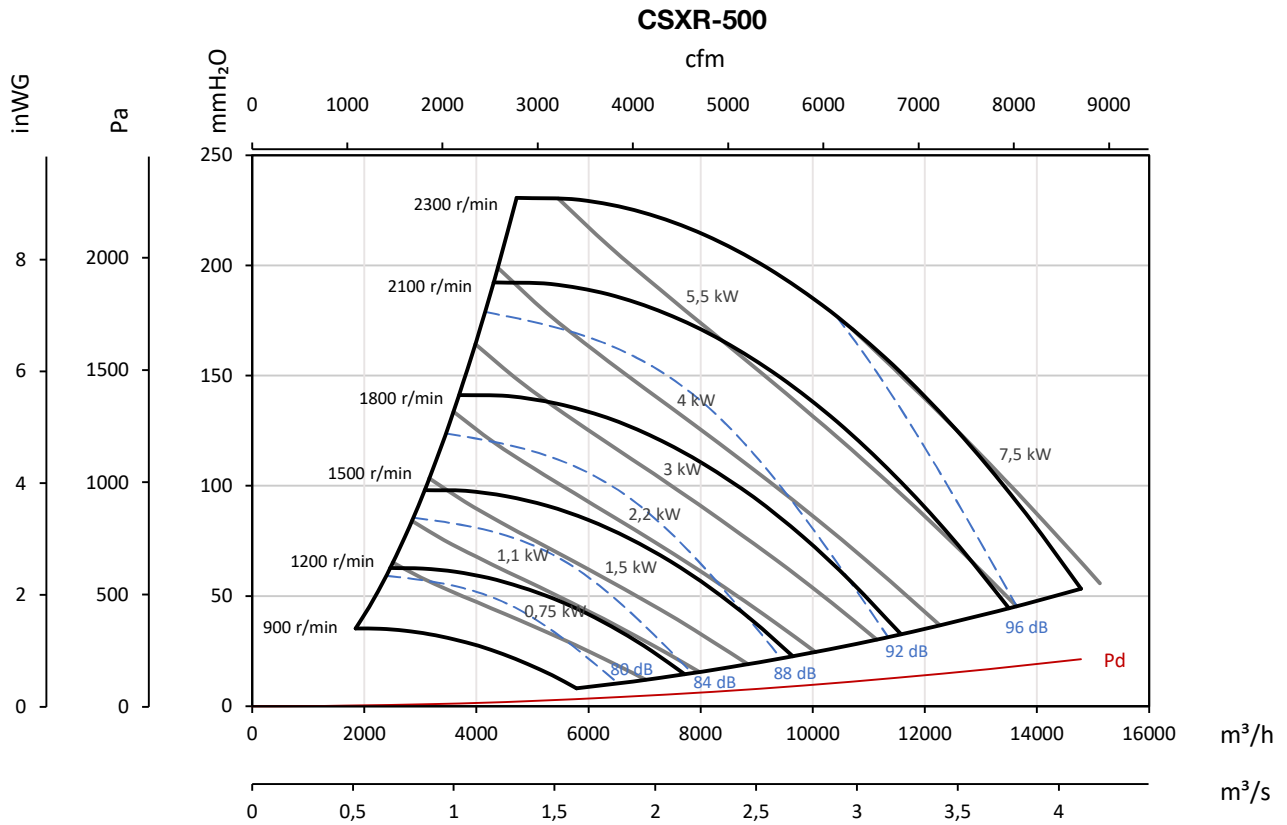

Curve caratteristiche

Q= Portata in m³/h, m³/s e cfm

Pe= Pressione statica in mmH₂O, Pa e inWG

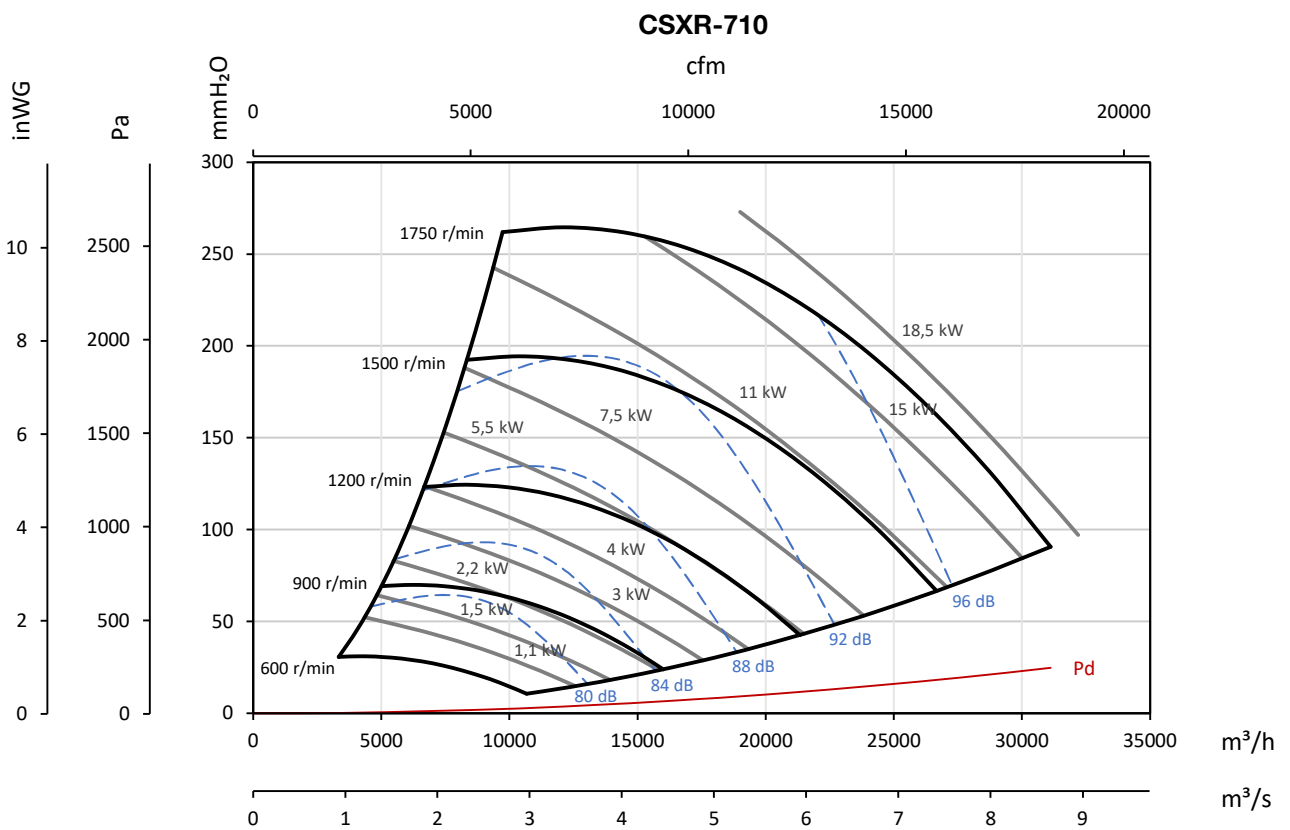
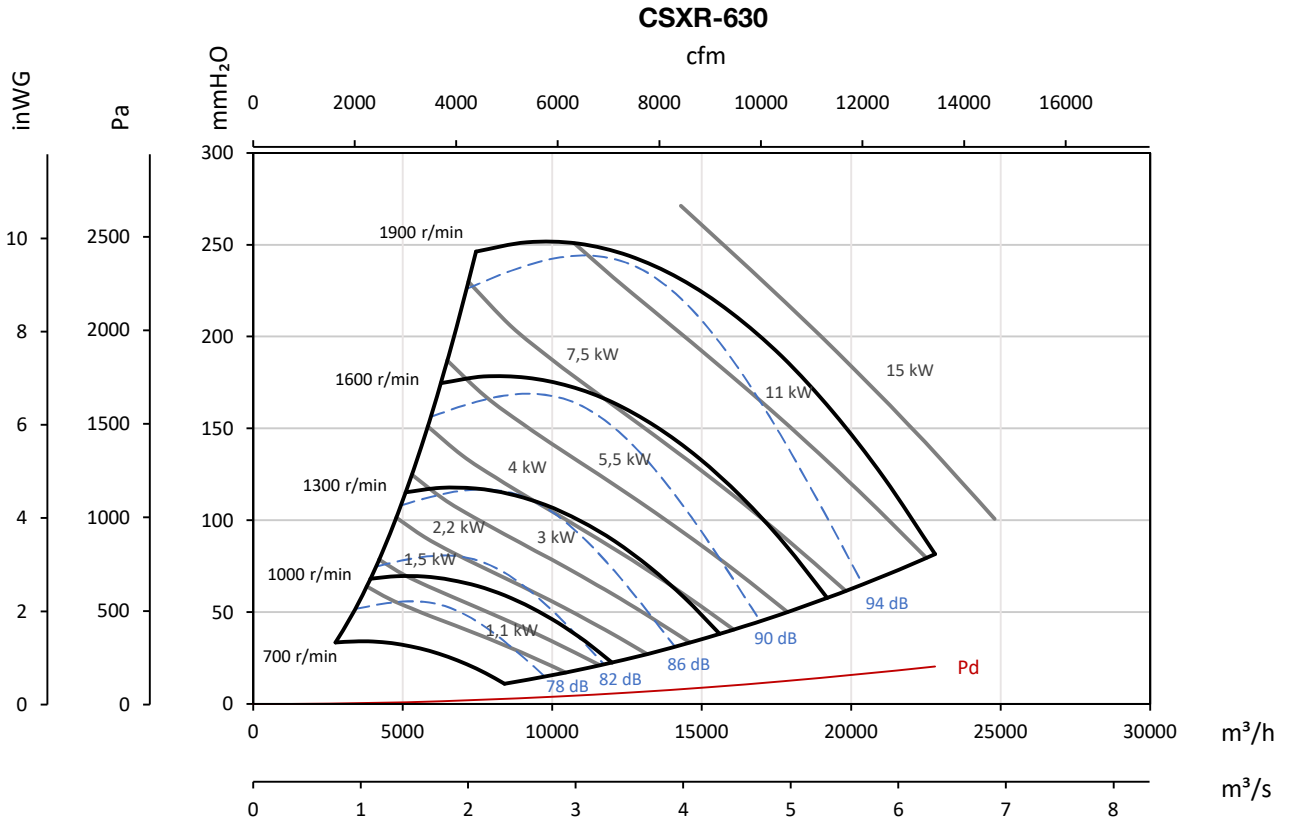

Curve caratteristiche

Q= Portata in m³/h, m³/s e cfm

Pe= Pressione statica in mmH₂O, Pa e inwg

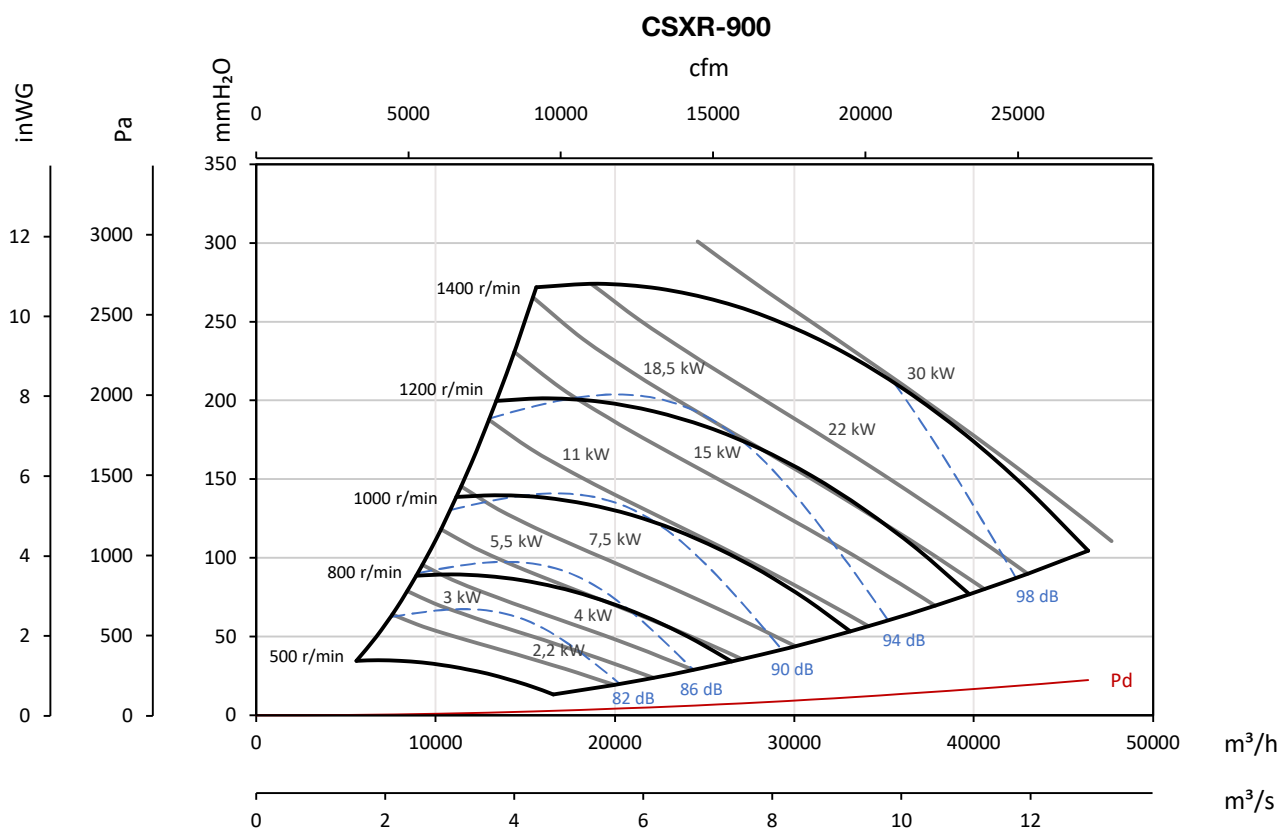
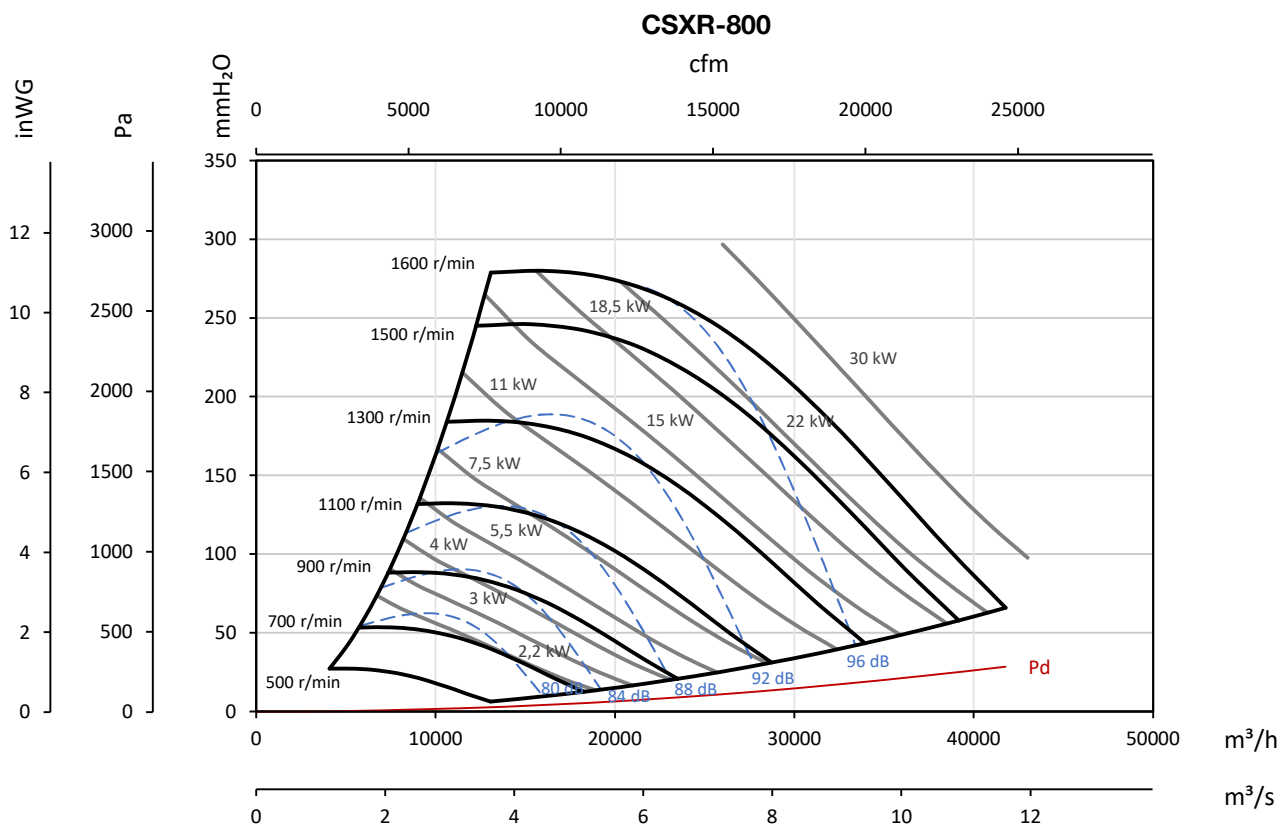

Curve caratteristiche

Q= Portata in m³/h, m³/s e cfm

Pe= Pressione statica in mmH₂O, Pa e inWG

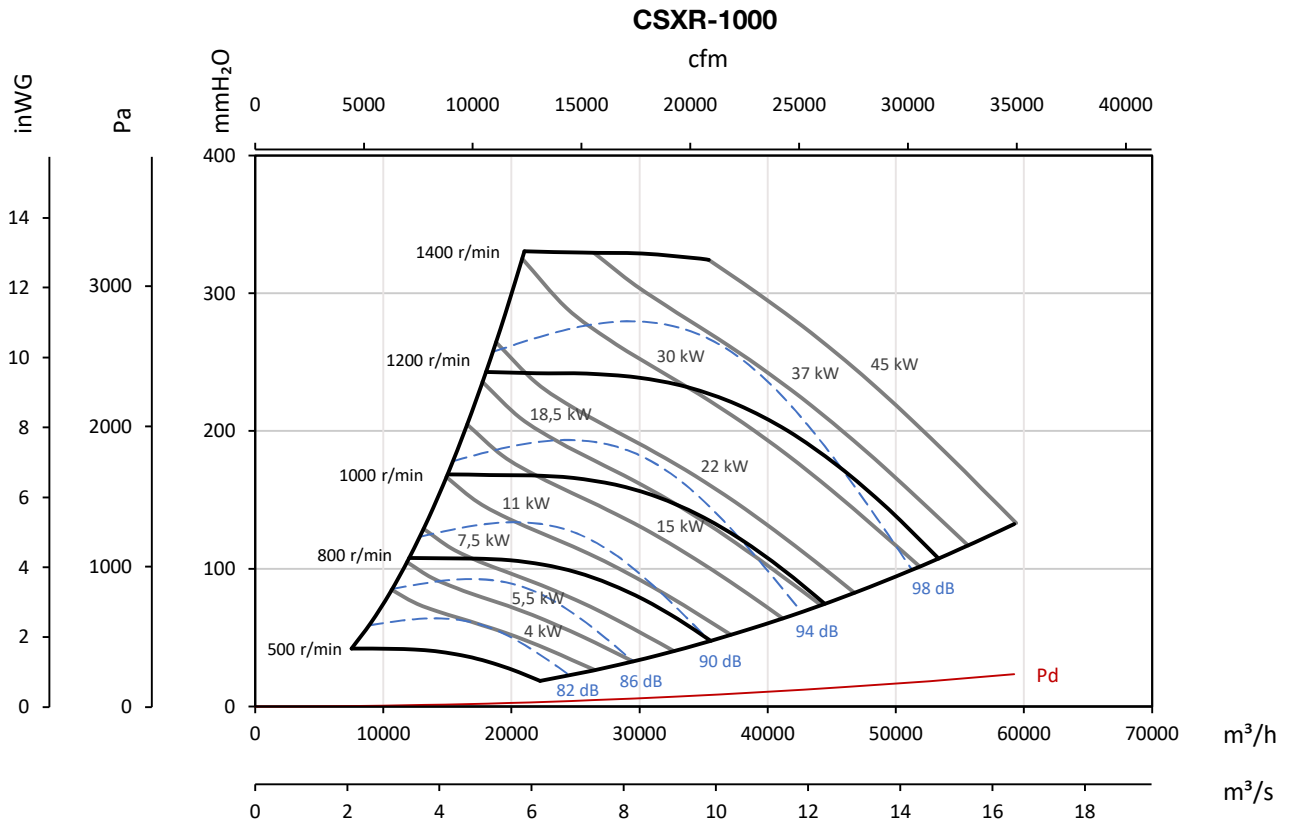

Accessori



INT



VSD3/A-RFT
- VSD1/A-RFM



AET



ACE ACE/400