

CJTHT/ATEX

Unità di estrazione assiali 400 °C/2h e 300 °C/2h, con certificazione ATEX 3G per zona 2



Unità di estrazione con ventilatori assiali per il funzionamento all'interno di zone a rischio incendio e certificazione ATEX 3G per zona 2.

Ventilatore:

- Ventilatore con rivestimento tubolare in lamiera di acciaio.
- Struttura in lamiera di acciaio galvanizzato con isolamento termico e acustico.
- Eliche a inclinazione variabile in alluminio pressofuso.
- Omologazione secondo la norma EN 12101-3, con certificazioni n. 0370-CPR-0312 (F400) e 0370-CPR-0974 (F300).

Motore:

- Motori in classe H per uso continuo S1 e di emergenza S2. Con cuscinetti a sfere, grado di protezione IP55, a 1 o 2 velocità in base al modello.
- Motori di efficienza IE3 per potenze uguali o superiori a 0,75 kW, ad esclusione delle versioni monofase, 2 velocità e 8 poli.

- Trifase 230/400 V 50 Hz (fino a 3 kW) e 400/690 V 50 Hz (potenze superiori a 3 kW).
- Temperatura massima dell'aria da movimentare: Servizio S1 -20 °C +40 °C in continuo, adatto anche per climi caldi con temperature fino a 50 °C. Servizio S2 300 °C/2h, 400 °C/2h.

Finitura:

- Ventilatore: Anticorrosiva in resina di poliestere polimerizzata a 190 °C, previo sgrassaggio con trattamento nanotecnologico senza fosfati.
- Scatola: Lamiera di acciaio galvanizzato.

Versioni disponibili:

- CJTHT: Ventilatori assiali con scatola dotata di isolamento acustico.
- CJTHT/PLUS: Ventilatori assiali con attenuatore acustico.

Su richiesta:

- Direzione aria girante-motore.
- Giranti totalmente reversibile.

Codice per ordine

Dalla dimensione 40 alla dimensione 100

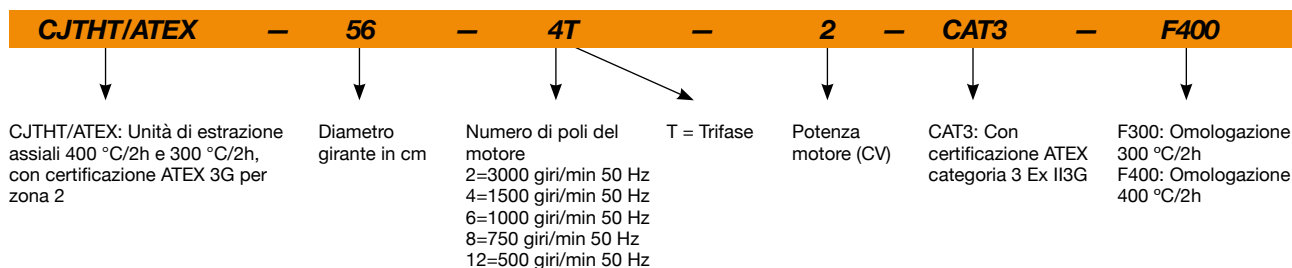

Dimensione 125

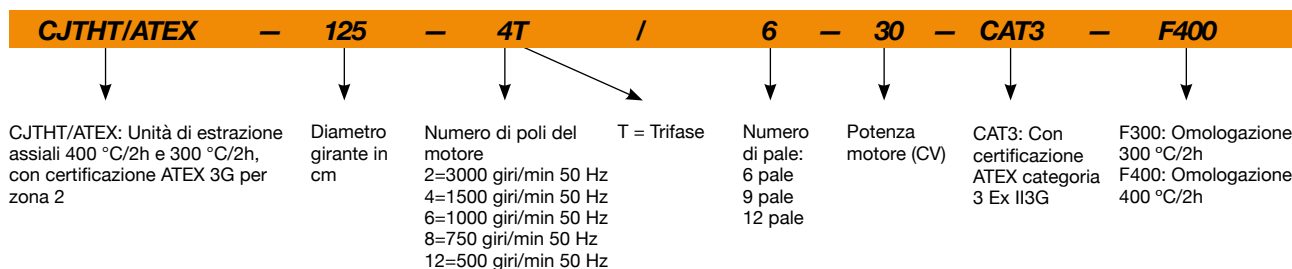

Caratteristiche tecniche

Modello	Velocità (giri/min)	Intensità massima consentita (A)			Potenza installata (kW)	Angolo di inclinazione delle pale (°)	Portata massima (m³/h)	Livello di pressione sonora ¹ dB (A) Aspirazione	Peso circa (Kg)
		230V	400V	690V					
CJTHT/ATEX-40-2/4T-1.5/CAT3	2920 / 1445		2,89 / 1,04		1,10 / 0,25	20	7040 / 3480	71 / 56	50
CJTHT/ATEX-40-4T-0.75/CAT3	1420	2,42	1,40		0,55	32	4820	55	41
CJTHT/ATEX-40-6T-0.75/CAT3	930	3,01	1,73		0,55	32	3150	46	49
CJTHT/ATEX-40-6/12T-0.75/CAT3	940 / 455		2,35 / 1,15		0,60 / 0,15	32	3150 / 1520	46 / 31	53
CJTHT/ATEX-45-2/4T-2/CAT3	2940 / 1465		3,58 / 1,19		1,50 / 0,37	16	9400 / 4680	71 / 56	53
CJTHT/ATEX-45-4T-0.75/CAT3	1420	2,42	1,40		0,55	36	7470	58	43
CJTHT/ATEX-45-6T-0.75/CAT3	930	3,01	1,73		0,55	30	4460	48	51
CJTHT/ATEX-45-6/12T-0.75/CAT3	940 / 455		2,35 / 1,15		0,60 / 0,15	30	4460 / 2150	48 / 33	55
CJTHT/ATEX-50-4T-0.75/CAT3	1425	2,42	1,40		0,55	22	8390	60	48
CJTHT/ATEX-50-6T-0.75/CAT3	930	3,01	1,73		0,55	32	7030	52	52
CJTHT/ATEX-56-4T-1/CAT3	1420	3,08	1,79		0,75	22	11280	63	59
CJTHT/ATEX-56-4T-1.5/CAT3	1420	4,10	2,37		1,10	30	13550	63	61
CJTHT/ATEX-56-4/8T-1.5/CAT3	1440 / 705		2,69 / 1,12		1,10 / 0,25	30	13550 / 6610	63 / 48	65
CJTHT/ATEX-56-4T-2/CAT3	1425	5,89	3,38		1,50	36	15030	64	63
CJTHT/ATEX-56-6T-0.75/CAT3	930	3,01	1,73		0,55	38	10140	54	61
CJTHT/ATEX-56-6/12T-0.75/CAT3	940 / 455		2,35 / 1,15		0,60 / 0,15	38	10140 / 4890	54 / 39	65
CJTHT/ATEX-63-4T-1/CAT3	1420	3,08	1,79		0,75	14	15190	67	63
CJTHT/ATEX-63-4T-1.5/CAT3	1420	4,10	2,37		1,10	20	17800	66	66
CJTHT/ATEX-63-4/8T-1.5/CAT3	1440 / 705		2,69 / 1,12		1,10 / 0,25	20	17800 / 8680	66 / 51	69
CJTHT/ATEX-63-4T-2/CAT3	1425	5,89	3,38		1,50	24	19280	66	67
CJTHT/ATEX-63-4/8T-2/CAT3	1415 / 715		3,40 / 1,65		1,50 / 0,30	24	19280 / 9740	66 / 52	74
CJTHT/ATEX-63-4T-3/CAT3	1435	7,86	4,52		2,20	32	22170	68	73
CJTHT/ATEX-63-4/8T-3/CAT3	1415 / 700		4,80 / 1,85		2,20 / 0,45	32	22170 / 10930	68 / 53	87
CJTHT/ATEX-63-4T-4/CAT3	1430	11,01	6,33		3,00	38	24240	69	78
CJTHT/ATEX-63-4/8T-4/CAT3	1425 / 710		6,45 / 2,28		3,00 / 0,60	38	24240 / 12070	69 / 54	91
CJTHT/ATEX-63-6T-0.75/CAT3	930	3,01	1,73		0,55	28	13590	57	66
CJTHT/ATEX-63-6/12T-0.75/CAT3	940 / 455		2,35 / 1,15		0,60 / 0,15	28	13590 / 6550	57 / 42	69
CJTHT/ATEX-63-6T-1/CAT3	940	3,36	1,93		0,75	38	15890	58	67
CJTHT/ATEX-63-6/12T-1/CAT3	935 / 455		3,75 / 2,76		0,80 / 0,20	38	15890 / 7700	58 / 43	71
CJTHT/ATEX-71-4T-1.5/CAT3	1420	4,10	2,37		1,10	12	19480	71	82
CJTHT/ATEX-71-4/8T-1.5/CAT3	1440 / 705		2,69 / 1,12		1,10 / 0,25	12	19480 / 9500	71 / 56	86
CJTHT/ATEX-71-4T-2/CAT3	1425	5,89	3,38		1,50	14	20920	70	84
CJTHT/ATEX-71-4/8T-2/CAT3	1415 / 715		3,40 / 1,65		1,50 / 0,30	14	20920 / 10570	70 / 56	91
CJTHT/ATEX-71-4T-3/CAT3	1435	7,86	4,52		2,20	22	25110	70	90
CJTHT/ATEX-71-4/8T-3/CAT3	1415 / 700		4,80 / 1,85		2,20 / 0,45	22	25110 / 12380	70 / 55	103
CJTHT/ATEX-71-4T-4/CAT3	1430	11,01	6,33		3,00	28	27480	70	95
CJTHT/ATEX-71-4/8T-4/CAT3	1425 / 710		6,45 / 2,28		3,00 / 0,60	28	27480 / 13680	70 / 55	108
CJTHT/ATEX-71-6T-0.75/CAT3	930	3,01	1,73		0,55	20	16100	60	82
CJTHT/ATEX-71-6/12T-0.75/CAT3	940 / 455		2,35 / 1,15		0,60 / 0,15	20	16100 / 7760	60 / 45	86
CJTHT/ATEX-71-6T-1/CAT3	940	3,36	1,93		0,75	26	17310	60	84
CJTHT/ATEX-71-6/12T-1/CAT3	935 / 455		3,75 / 2,76		0,80 / 0,20	26	17310 / 8390	60 / 45	87
CJTHT/ATEX-71-6T-1.5/CAT3	945	4,73	2,72		1,10	34	19930	61	86
CJTHT/ATEX-71-6/12T-1.5/CAT3	940 / 460		3,52 / 2,00		1,20 / 0,30	34	19930 / 9760	61 / 46	97
CJTHT/ATEX-80-4T-3/CAT3	1435	7,86	4,52		2,20	12	25460	75	98
CJTHT/ATEX-80-4/8T-3/CAT3	1415 / 700		4,80 / 1,85		2,20 / 0,45	12	25460 / 12550	75 / 60	111
CJTHT/ATEX-80-4T-4/CAT3	1430	11,01	6,33		3,00	16	30270	74	103
CJTHT/ATEX-80-4/8T-4/CAT3	1425 / 710		6,45 / 2,28		3,00 / 0,60	16	30270 / 15070	74 / 59	115
CJTHT/ATEX-80-4T-5.5/CAT3	1440		7,95	4,61	4,00	18	32770	73	113
CJTHT/ATEX-80-4/8T-5.5/CAT3	1455 / 720		7,88 / 2,87		3,80 / 1,00	18	32770 / 16160	73 / 58	147
CJTHT/ATEX-80-6T-1.5/CAT3	945	4,73	2,72		1,10	18	21470	63	95
CJTHT/ATEX-80-6/12T-1.5/CAT3	940 / 460		3,52 / 2,00		1,20 / 0,30	18	21470 / 10510	63 / 48	105
CJTHT/ATEX-80-6T-2/CAT3	945	6,25	3,62		1,50	26	25970	64	99
CJTHT/ATEX-80-6/12T-2/CAT3	960 / 470		4,46 / 3,43		1,60 / 0,40	26	25970 / 12710	64 / 49	113
CJTHT/ATEX-80-6T-3/CAT3	950	9,78	5,62		2,20	32	29930	65	113

Caratteristiche tecniche

Modello	Velocità (giri/min)	Intensità massima consentita (A)			Potenza installata (kW)	Angolo di inclinazione delle pale (°)	Portata massima (m³/h)	Livello di pressione sonora ¹ dB (A) Aspirazione	Peso circa (Kg)
		230V	400V	690V					
CJTHT/ATEX-80-6/12T-3/CAT3	940 / 475		5,62 / 3,32		2,20 / 0,55	32	29930 / 15120	65 / 51	118
CJTHT/ATEX-80-8T-0.75/CAT3	700	3,48	2,00		0,55	20	17540	57	99
CJTHT/ATEX-80-8T-1/CAT3	710	4,29	2,36		0,75	28	20680	58	111
CJTHT/ATEX-90-4T-4/CAT3	1430	11,01	6,33		3,00	8	33580	79	127
CJTHT/ATEX-90-4/8T-4/CAT3	1425 / 710		6,45 / 2,28		3,00 / 0,60	8	33580 / 16720	79 / 64	139
CJTHT/ATEX-90-4T-5.5/CAT3	1440		7,95	4,61	4,00	12	38890	78	137
CJTHT/ATEX-90-4/8T-5.5/CAT3	1455 / 720		7,88 / 2,87		3,80 / 1,00	12	38890 / 19170	78 / 63	171
CJTHT/ATEX-90-4T-7.5/CAT3	1460		10,40	6,04	5,50	18	46140	77	171
CJTHT/ATEX-90-4/8T-7.5/CAT3	1455 / 725		11,40 / 3,86		5,50 / 1,10	18	46140 / 22910	77 / 62	190
CJTHT/ATEX-90-4T-10/CAT3	1460		14,20	8,17	7,50	22	50140	76	208
CJTHT/ATEX-90-4/8T-10/CAT3	1455 / 725		15,10 / 5,16		7,50 / 1,50	22	50140 / 24900	76 / 61	198
CJTHT/ATEX-90-6T-2/CAT3	945	6,25	3,62		1,50	16	28780	66	123
CJTHT/ATEX-90-6/12T-2/CAT3	960 / 470		4,46 / 3,43		1,60 / 0,40	16	28780 / 14090	66 / 51	137
CJTHT/ATEX-90-6T-3/CAT3	950	9,78	5,62		2,20	24	34000	66	137
CJTHT/ATEX-90-6/12T-3/CAT3	940 / 475		5,62 / 3,32		2,20 / 0,55	24	34000 / 17180	66 / 52	142
CJTHT/ATEX-90-6T-4/CAT3	970	12,80	6,36		3,00	30	38910	69	171
CJTHT/ATEX-90-6/12T-4/CAT3	970 / 485		7,37 / 3,53		2,80 / 0,70	30	38910 / 19460	69 / 54	171
CJTHT/ATEX-90-8T-1/CAT3	710	4,29	2,36		0,75	18	22910	60	135
CJTHT/ATEX-90-8T-2/CAT3	700	7,32	4,21		1,50	30	29490	63	139
CJTHT/ATEX-90-8T-3/CAT3	710		5,44	3,16	2,20	32	30850	64	171
CJTHT/ATEX-100-4T-7.5/CAT3	1460		10,40	6,04	5,50	10	46870	82	179
CJTHT/ATEX-100-4/8T-7.5/CAT3	1455 / 725		11,40 / 3,86		5,50 / 1,10	10	46870 / 23270	82 / 67	198
CJTHT/ATEX-100-4T-10/CAT3	1460		14,20	8,17	7,50	16	57420	79	216
CJTHT/ATEX-100-4/8T-10/CAT3	1455 / 725		15,10 / 5,16		7,50 / 1,50	14	54710 / 27170	80 / 65	206
CJTHT/ATEX-100-4T-15/CAT3	1460		20,70	11,99	11,00	22	66300	79	251
CJTHT/ATEX-100-4/8T-15/CAT3	1470 / 730		20,70 / 7,19		11,00 / 3,00	22	66300 / 32880	79 / 64	251
CJTHT/ATEX-100-4T-20/CAT3	1460		27,80	16,03	15,00	28	76160	80	258
CJTHT/ATEX-100-4/8T-20/CAT3	1470 / 725		31,72 / 11,75		15,00 / 3,80	28	76160 / 37560	80 / 65	258
CJTHT/ATEX-100-4T/9-15/CAT3	1460		20,70	11,99	11,00	18	55345	80	260
CJTHT/ATEX-100-4T/9-20/CAT3	1460		27,80	16,03	15,00	22	63265	80	268
CJTHT/ATEX-100-4T/9-25/CAT3	1475		35,40	20,39	18,50	26	70625	80	308
CJTHT/ATEX-100-4T/9-30/CAT3	1475		42,20	24,44	22,00	30	74845	82	316
CJTHT/ATEX-100-6T-3/CAT3	950	9,78	5,62		2,20	16	37620	70	145
CJTHT/ATEX-100-6/12T-3/CAT3	940 / 475		5,62 / 3,32		2,20 / 0,55	16	37620 / 19000	70 / 56	150
CJTHT/ATEX-100-6T-4/CAT3	970	12,80	6,36		3,00	20	41180	69	179
CJTHT/ATEX-100-6/12T-4/CAT3	970 / 485		7,37 / 3,53		2,80 / 0,70	20	41180 / 20590	69 / 54	179
CJTHT/ATEX-100-6T-5.5/CAT3	970		8,37	4,82	4,00	26	47780	70	187
CJTHT/ATEX-100-6T/9-5.5/CAT3	970		8,37	4,82	4,00	20	39020	70	196
CJTHT/ATEX-100-6T/9-7.5/CAT3	970		12,30	7,07	5,50	26	46765	71	200
CJTHT/ATEX-100-6T/9-10/CAT3	970		15,20	8,83	7,50	34	52255	74	225
CJTHT/ATEX-125-4T/6-20/CAT3	1455		27,80	16,03	15,00	10	78610	87	466
CJTHT/ATEX-125-4/8T/6-20/CAT3	1455 / 720		31,72 / 11,75		15,00 / 3,80	10	78610 / 38770	87 / 72	485
CJTHT/ATEX-125-4T/6-25/CAT3	1470		35,40	20,39	18,50	14	92000	86	549
CJTHT/ATEX-125-4/8T/6-27/CAT3	1470 / 730		39,70 / 14,10		20,00 / 5,00	16	98100 / 48550	85 / 70	557
CJTHT/ATEX-125-4T/6-30/CAT3	1470		42,20	24,44	22,00	16	98830	85	554
CJTHT/ATEX-125-4/8T/6-37/CAT3	1480 / 740		54,55 / 18,50		28,00 / 6,50	20	110250 / 54940	85 / 70	633
CJTHT/ATEX-125-4T/6-40/CAT3	1475		53,3	31,02	30,00	22	117000	85	606
CJTHT/ATEX-125-4T/6-50/CAT3	1480		66,40	38,26	37,00	26	130450	85	734
CJTHT/ATEX-125-4T/6-60/CAT3	1475		80,90	46,90	45,00	28	135820	85	747
CJTHT/ATEX-125-4T/6-75/CAT3	1480		98,60	57,20	55,00	34	152100	88	828
CJTHT/ATEX-125-4T/9-25/CAT3	1470		35,40	20,39	18,50	10	79680	87	558
CJTHT/ATEX-125-4T/9-30/CAT3	1470		42,20	24,44	22,00	12	88290	86	563
CJTHT/ATEX-125-4/8T/9-27/CAT3	1470 / 730		39,70 / 14,10		20,00 / 5,00	12	88290 / 43690	86 / 71	566
CJTHT/ATEX-125-4/8T/9-37/CAT3	1480 / 740		54,55 / 18,50		28,00 / 6,50	16	104040 / 51840	85 / 70	642

Caratteristiche tecniche

Modello	Velocità (giri/min)	Intensità massima consentita (A)			Potenza installata (kW)	Angolo di inclinazione delle pale (°)	Portata massima (m³/h)	Livello di pressione sonora¹ dB (A) Aspirazione	Peso circa (Kg)
		230V	400V	690V					
CJTHT/ATEX-125-4T/9-40/CAT3	1475		53,3	31,02	30,00	16	104040	85	615
CJTHT/ATEX-125-4T/9-50/CAT3	1480		66,40	38,26	37,00	20	118350	85	743
CJTHT/ATEX-125-4T/9-60/CAT3	1475		80,90	46,90	45,00	24	134970	85	756
CJTHT/ATEX-125-4T/9-75/CAT3	1480		98,60	57,20	55,00	28	146770	86	837
CJTHT/ATEX-125-4T/9-100/CAT3	1480		128,00	74,22	75,00	34	158560	88	998
CJTHT/ATEX-125-4T/12-50/CAT3	1480		66,4	38,26	37,00	18	101660	86	752
CJTHT/ATEX-125-4T/12-60/CAT3	1475		80,90	46,90	45,00	20	109180	86	765
CJTHT/ATEX-125-4T/12-75/CAT3	1480		98,60	57,20	55,00	26	131240	86	846
CJTHT/ATEX-125-4T/12-100/CAT3	1480		128,00	74,22	75,00	32	154100	88	1016
CJTHT/ATEX-125-6T/6-5.5/CAT3	940		8,37	4,82	4,00	10	51300	77	402
CJTHT/ATEX-125-6T/6-7.5/CAT3	960		12,30	7,07	5,50	14	60640	75	410
CJTHT/ATEX-125-6/12T/6-7.5/CAT3	980 / 485		14,50 / 5,17		5,50 / 1,00	14	60640 / 30010	75 / 60	454
CJTHT/ATEX-125-6T/6-10/CAT3	970		15,20	8,83	7,50	20	72250	74	458
CJTHT/ATEX-125-6/12T/6-10/CAT3	975 / 490		13,6 / 5,69		7,20 / 1,80	20	72250 / 36310	74 / 60	466
CJTHT/ATEX-125-6T/6-15/CAT3	970		22,50	13,07	11,00	26	85450	74	475
CJTHT/ATEX-125-6/12T/6-15/CAT3	975 / 485		23,1 / 8,41		11,00 / 3,00	26	85450 / 42510	74 / 59	566
CJTHT/ATEX-125-6T/6-20/CAT3	970		29,00	16,78	15,00	30	92860	76	542
CJTHT/ATEX-125-6/12T/6-24/CAT3	980 / 485		41,60 / 13,21		17,60 / 2,85	34	99650 / 49320	78 / 63	631
CJTHT/ATEX-125-6T/9-10/CAT3	970		15,20	8,83	7,50	14	63490	77	467
CJTHT/ATEX-125-6/12T/9-10/CAT3	975 / 490		13,6 / 5,69		7,20 / 1,80	14	63490 / 31910	77 / 63	475
CJTHT/ATEX-125-6T/9-15/CAT3	970		22,50	13,07	11,00	20	77550	75	484
CJTHT/ATEX-125-6/12T/9-15/CAT3	975 / 485		23,1 / 8,41		11,00 / 3,00	20	77550 / 38580	75 / 60	575
CJTHT/ATEX-125-6T/9-20/CAT3	970		29,00	16,78	15,00	26	92950	75	551
CJTHT/ATEX-125-6/12T/9-24/CAT3	980 / 485		41,60 / 13,21		17,60 / 2,85	30	98530 / 48760	76 / 61	640
CJTHT/ATEX-125-6T/9-25/CAT3	975		36,10	20,77	18,50	32	101450	77	627
CJTHT/ATEX-125-6T/9-30/CAT3	975		42,30	24,35	22,00	36	106525	80	638
CJTHT/ATEX-125-6T/12-10/CAT3	970		15,20	8,83	7,50	12	49630	79	476
CJTHT/ATEX-125-6T/12-15/CAT3	970		22,50	13,07	11,00	18	67315	77	493
CJTHT/ATEX-125-6T/12-20/CAT3	970		29,00	16,78	15,00	24	81840	76	560
CJTHT/ATEX-125-6T/12-25/CAT3	975		36,10	20,77	18,50	30	96765	77	636
CJTHT/ATEX-125-6T/12-30/CAT3	975		42,30	24,35	22,00	32	102040	78	647
CJTHT/ATEX-125-6T/12-40/CAT3	985		56,00	32,50	30,00	34	106355	79	762

1 I valori dei livelli di rumore sono pressioni in dB(A), misurate in campo libero a una distanza di 3 metri.

Caratteristiche acustiche

Spettro di potenza sonora Lw(A) in dB(A) per banda di frequenza in Hz
Valori presi in aspirazione con portata massima

	63	125	250	500	1000	2000	4000	8000		63	125	250	500	1000	2000	4000	8000
40-2-1.5	47	63	75	83	88	86	82	75	56-12-0.75 (2V)	29	39	49	53	54	52	45	37
40-4-1.5 (2V)	32	48	60	68	73	71	67	60	63-4-1	48	64	76	82	84	81	74	66
40-4-0.75	37	53	63	70	71	68	67	68	63-4-1.5	47	63	75	81	83	80	73	65
40-6-0.75	28	44	54	61	62	59	58	59	63-8-1.5 (2V)	31	47	59	65	67	64	57	49
40-12-0.75 (2V)	12	28	38	45	46	43	42	43	63-4-2	54	66	75	81	81	81	75	67
45-2-2	47	60	74	86	87	86	82	74	63-8-2 (2V)	39	51	60	66	66	66	60	52
45-4-2 (2V)	32	45	59	71	72	71	67	59	63-4-3	56	68	77	83	83	83	77	69
45-4-0.75	47	59	67	73	73	73	68	60	63-8-3 (2V)	41	53	62	68	68	68	62	54
45-6-0.75	37	49	57	63	63	63	58	50	63-4-4	57	69	78	84	84	84	78	70
45-12-0.75 (2V)	21	33	41	47	47	47	42	34	63-8-4 (2V)	42	54	63	69	69	69	63	55
50-4-0.75	49	61	69	75	75	75	70	62	63-6-0.75	48	58	68	72	73	71	64	56
50-6-0.75	41	53	61	67	67	67	62	54	63-12-0.75 (2V)	32	42	52	56	57	55	48	40
56-4-1	51	63	72	78	78	78	72	64	63-6-1	49	59	69	73	74	72	65	57
56-4-1.5	51	63	72	78	78	78	72	64	63-12-1 (2V)	33	43	53	57	58	56	49	41
56-8-1.5 (2V)	35	47	56	62	62	62	56	48	71-4-1.5	57	73	80	86	86	86	82	74
56-4-2	52	64	73	79	79	79	73	65	71-8-1.5 (2V)	41	57	64	70	70	70	66	58
56-6-0.75	45	55	65	69	70	68	61	53	71-4-2	56	72	79	85	85	85	81	73

Caratteristiche acustiche

Spettro di potenza sonora Lw(A) in dB(A) per banda di frequenza in Hz
Valori presi in aspirazione con portata massima

	63	125	250	500	1000	2000	4000	8000		63	125	250	500	1000	2000	4000	8000
71-8-2 (2V)	41	57	64	70	70	70	66	58	100-12-4 (2V)	41	56	66	69	70	67	59	51
71-4-3	56	72	79	85	85	85	81	73	100-6-5.5	57	72	82	85	86	83	75	67
71-8-3 (2V)	41	57	64	70	70	70	66	58	100-6/9-5.5	57	72	82	85	86	83	75	67
71-4-4	63	75	79	85	85	86	83	75	100-6/9-7.5	58	73	83	86	87	84	76	68
71-8-4 (2V)	48	60	64	70	70	71	68	60	100-6/9-10	61	76	86	89	90	87	79	71
71-6-0.75	46	53	73	76	76	71	63	55	125-4/6-20	69	85	96	103	104	102	95	87
71-12-0.75 (2V)	30	37	57	60	60	55	47	39	125-8/6-20 (2V)	54	70	81	88	89	87	80	72
71-6-1	46	64	73	76	76	71	64	55	125-4/6-25	68	84	95	102	103	101	94	86
71-12-1 (2V)	30	48	57	60	60	55	48	39	125-4/6-27	67	83	94	101	102	100	93	85
71-6-1.5	47	65	74	77	77	72	65	56	125-8/6-27 (2V)	52	68	79	86	87	85	78	70
71-12-1.5 (2V)	31	49	58	61	61	56	49	40	125-4/6-30	67	83	94	101	102	100	93	85
80-4-3	55	71	84	91	91	88	82	74	125-4/6-37	67	83	94	101	102	100	93	85
80-8-3 (2V)	40	56	69	76	76	73	67	59	125-8/6-37 (2V)	52	68	79	86	87	85	78	70
80-4-4	54	70	83	90	90	87	81	73	125-4/6-40	67	83	94	101	102	100	93	85
80-8-4 (2V)	39	55	68	75	75	72	66	58	125-4/6-50	67	83	94	101	102	100	93	85
80-4-5.5	53	69	82	89	89	86	80	72	125-4/6-60	67	83	94	101	102	100	93	85
80-8-5.5 (2V)	38	54	67	74	74	71	65	57	125-4/6-75	70	86	97	104	105	103	96	88
80-6-1.5	53	68	75	78	79	76	70	62	125-4/9-25	67	81	94	102	104	101	96	88
80-12-1.5 (2V)	37	52	59	62	63	60	54	46	125-4/9-27	66	80	93	101	103	100	95	87
80-6-2	59	69	75	79	80	78	73	65	125-8/9-27 (2V)	51	65	78	86	88	85	80	72
80-12-2 (2V)	43	53	59	63	64	62	57	49	125-4/9-30	66	80	93	101	103	100	95	87
80-6-3	60	70	76	80	81	79	74	66	125-4/9-37	65	79	92	100	102	99	94	86
80-12-3 (2V)	45	55	61	65	66	64	59	51	125-8/9-37 (2V)	50	64	77	85	87	84	79	71
80-8-0.75	46	59	67	72	74	71	64	53	125-4/9-40	65	79	92	100	102	99	94	86
80-8-1	47	60	68	73	75	72	65	54	125-4/9-50	65	79	92	100	102	99	94	86
90-4-4	61	77	88	94	95	93	88	80	125-4/9-60	73	86	95	99	101	100	96	89
90-8-4 (2V)	46	62	73	79	80	78	73	65	125-4/9-75	74	87	96	100	102	101	97	90
90-4-5.5	60	76	87	93	94	92	87	79	125-4/9-100	76	89	98	102	104	103	99	92
90-8-5.5 (2V)	45	61	72	78	79	77	72	64	125-4/12-50	66	80	93	101	103	100	95	87
90-4-7.5	59	75	86	92	93	91	86	78	125-4/12-60	66	80	93	101	103	100	95	87
90-8-7.5 (2V)	44	60	71	77	78	76	71	63	125-4/12-75	74	87	96	100	102	101	97	90
90-4-10	58	74	85	91	92	90	85	77	125-4/12-100	76	89	98	102	104	103	99	92
90-8-10 (2V)	43	59	70	76	77	75	70	62	125-6/6-5.5	64	79	89	92	93	90	85	77
90-6-2	52	67	78	82	82	78	71	63	125-6/6-7.5	62	77	87	90	91	88	83	75
90-12-2 (2V)	36	51	62	66	66	62	55	47	125-12/6-7.5 (2V)	47	62	72	75	76	73	68	60
90-6-3	52	67	78	82	82	78	71	63	125-6/6-10	61	76	86	89	90	87	82	74
90-12-3 (2V)	37	52	63	67	67	63	56	48	125-12/6-10 (2V)	46	61	71	74	75	72	67	59
90-6-4	60	70	80	85	85	82	76	68	125-6/6-15	61	76	86	89	90	87	82	74
90-12-4 (2V)	45	55	65	70	70	67	61	53	125-12/6-15 (2V)	46	61	71	74	75	72	67	59
90-8-1	42	63	70	75	78	74	67	56	125-6/6-20	63	78	88	91	92	89	84	76
90-8-2	51	66	73	78	81	77	70	59	125-6/6-24	65	80	90	93	94	91	86	78
90-8-3	53	67	74	79	82	78	71	60	125-12/6-24 (2V)	50	65	75	78	79	76	71	63
100-4-7.5	67	83	90	97	98	96	92	84	125-6/9-10	61	76	87	93	94	88	84	77
100-8-7.5 (2V)	52	68	75	82	83	81	77	69	125-12/9-10 (2V)	46	61	72	78	79	73	69	62
100-4-10	65	81	88	95	96	94	90	82	125-6/9-15	59	74	85	91	92	86	82	75
100-8-10 (2V)	50	66	73	80	81	79	75	67	125-12/9-15 (2V)	44	59	70	76	77	71	67	60
100-4-15	71	83	87	93	94	94	91	83	125-6/9-20	59	74	85	91	92	86	82	75
100-8-15 (2V)	56	68	72	78	79	79	76	68	125-6/9-24	60	75	86	92	93	87	83	76
100-4-20	72	84	88	94	95	95	92	84	125-12/9-24 (2V)	45	60	71	77	78	72	68	61
100-8-20 (2V)	57	69	73	79	80	80	77	69	125-6/9-25	61	76	87	93	94	88	84	77
100-4/9-15	65	81	88	95	96	94	90	82	125-6/9-30	64	79	90	96	97	91	87	80
100-4/9-20	72	84	88	94	95	95	92	84	125-6/12-10	63	78	89	95	96	90	86	79
100-4/9-25	72	84	88	94	95	95	92	84	125-6/12-15	61	76	87	93	94	88	84	77
100-4/9-30	74	86	90	96	97	97	94	86	125-6/12-20	60	75	86	92	93	87	83	76
100-6-3	57	72	82	85	86	83	75	67	125-6/12-25	61	76	87	93	94	88	84	77
100-12-3 (2V)	42	57	67	70	71	68	60	52	125-6/12-30	62	77	88	94	95	89	85	78
100-6-4	56	71	81	84	85	82	74	66	125-6/12-40	63	78	89	95	96	90	86	79

Dimensioni in mm

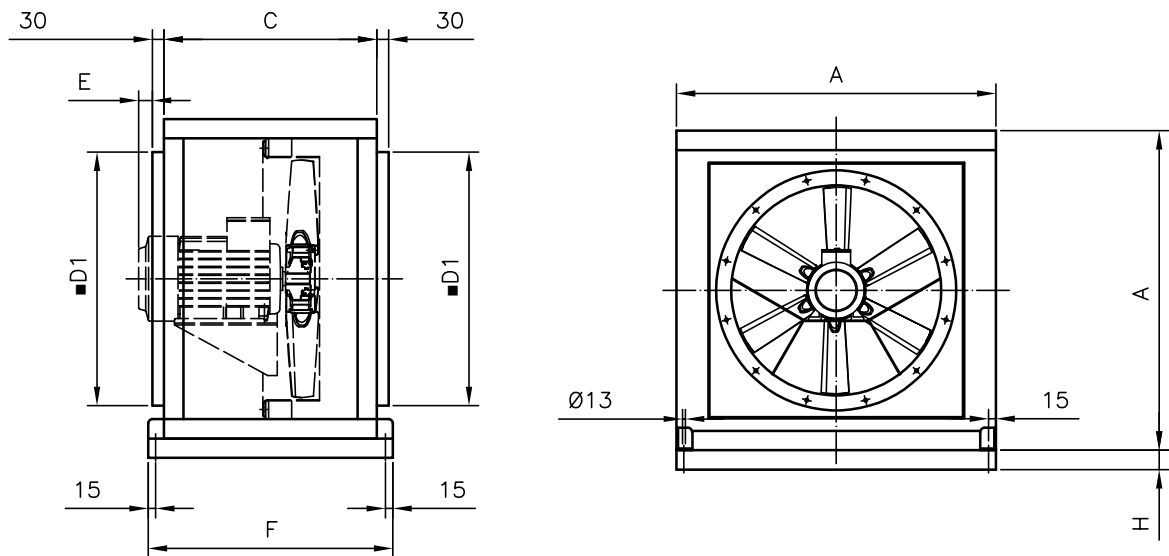

	A	C	ØD1	E	F	H
CJTHT/ATEX-40/45/50	700	550	565	-	630	-
CJTHT/ATEX-56/63	825	550	690	140	630	-
CJTHT/ATEX-71/80	1000	650	850	-	730	-
CJTHT/ATEX-90/100	1200	750	1050	-	830	-
CJTHT/ATEX-125 ≤20 CV	1600	1200	1400	-	1280	-
CJTHT/ATEX-125 >20 CV	1600	1200	1400	123	1280	100

Accessori



IAT



CABLE BOX



VSD3/A-RFT
- VSD1/A-RFM



CENTRAL CO



P-400



PT



PT/H



VIS



TEJ



S

ESEMPIO SELEZIONE

Curve caratteristiche

Q= Portata in m³/h, m³/s e cfm

Pe= Pressione statica in mmH₂O, Pa e inwg

Diametro girante in cm: 71

Numero di poli del motore: 6

Numero di pale: 6

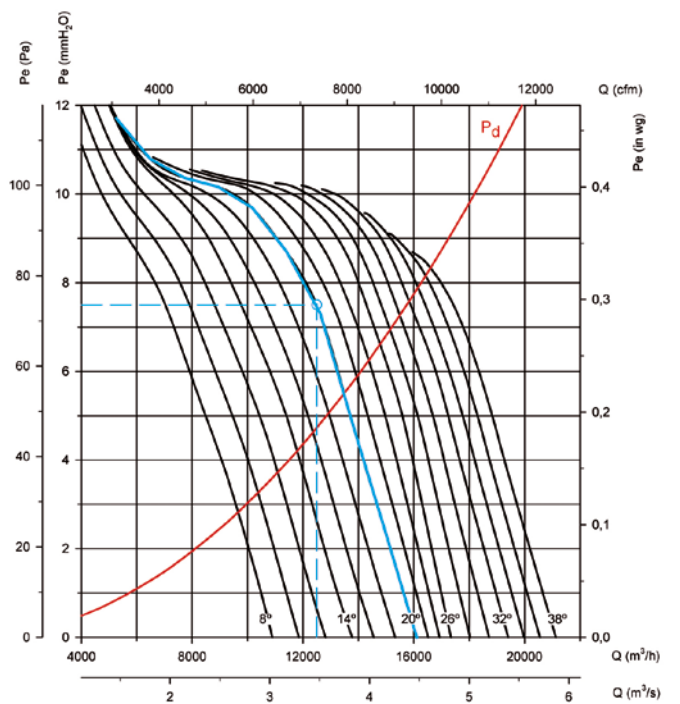

Dati di partenza

Punto di lavoro:

- Portata: 12.500 m³/h
- Perdita di carico: 7,5 mmH₂O

Tappe per la selezione del ventilatore

Nella grafica delle pressioni:

- Marcare il punto di lavoro, definito dalla portata di lavoro (12.500 m³/h) e la perdita di carico (7,5 mmH₂O).
- Scegliere la curva del ventilatore che più si avvicina al di sopra del punto di lavoro. Nel nostro caso si ottiene una curva di 20° di angolo di pala.

Nella grafica di potenza:

- Marcare il punto di lavoro, definito dalla portata di lavoro (12.500 m³/h) e la curva di angolo di pala scelto (20°).
- Leggere la potenza assorbita nell'asse di potenze sulla sinistra. La Pa= 510 W nel punto di lavoro.
- Cercare la linea rossa che più si avvicina alla parte superiore del punto di lavoro. Nella parte destra della grafica si ottiene il valore di potenza installata di motore. Nel nostro caso 0,55 kW o 0,75 CV.

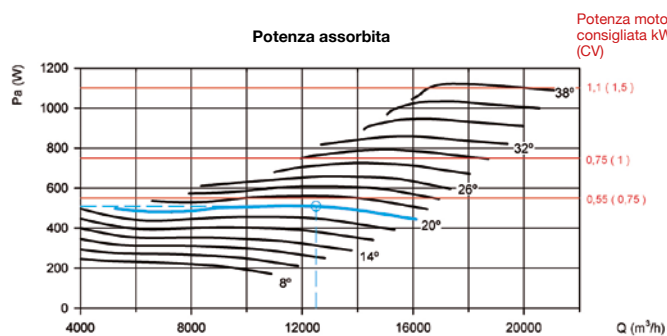

ESEMPIO DI CODICE PER ORDINE

CJTHT/ATEX		-	71	-	6T	-	0.75	-	CAT3	-	F400
Nome della serie: CJTHT/ATEX	Diametro girante in cm		Numero di poli del motore 2=3000 giri/min 50 Hz 4=1500 giri/min 50 Hz 6=1000 giri/min 50 Hz 8=750 giri/min 50 Hz 12=500 giri/min 50 Hz		T = Trifase		Potenza motore (CV)		CAT3: Con certificazione ATEX categoria 3 Ex II3G		F300: Omologazione 300 °C/2h F400: Omologazione 400 °C/2h

Curve caratteristiche

Q= Portata in m³/h, m³/s e cfm

Pe= Pressione statica in mmH₂O, Pa e inwg

Diametro girante in cm: 40

Numero di poli del motore: 2

Numero di pale: 6

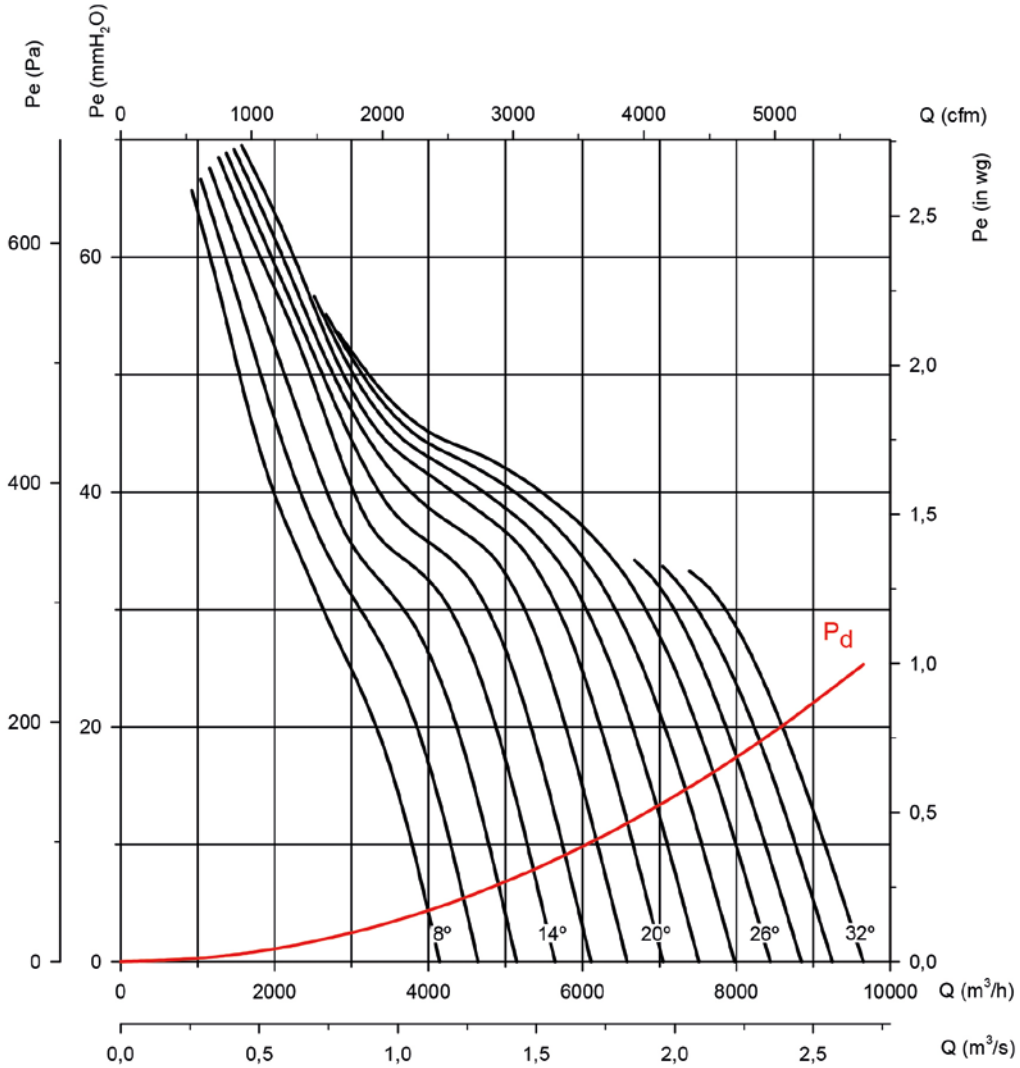

Potenza assorbita

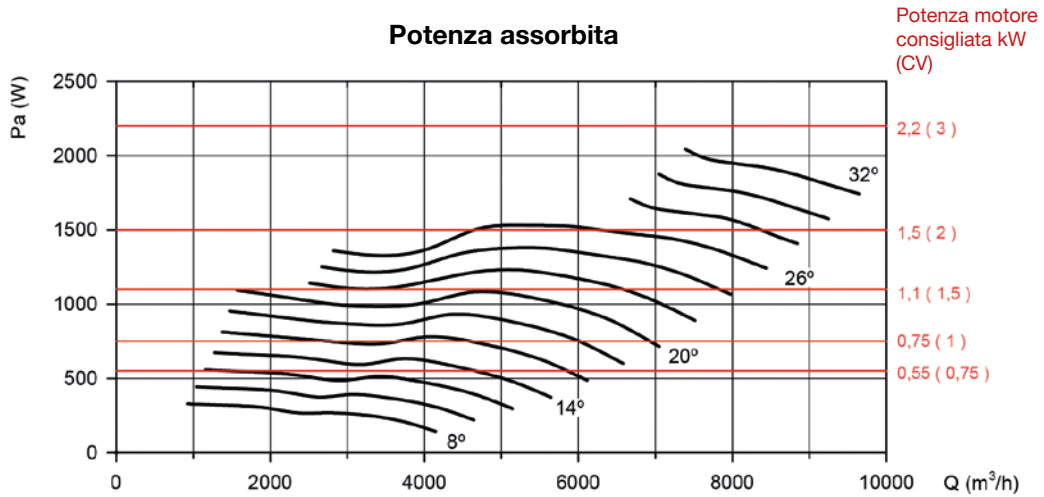

Curve caratteristiche

Q= Portata in m³/h, m³/s e cfm

Pe= Pressione statica in mmH₂O, Pa e inwg

Diametro girante in cm: 40

Numero di poli del motore: 4

Numero di pale: 6

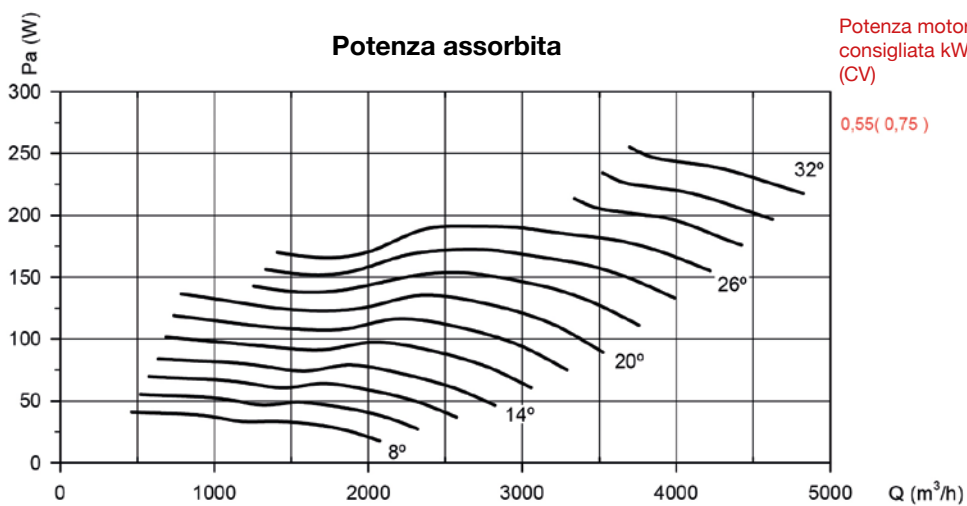
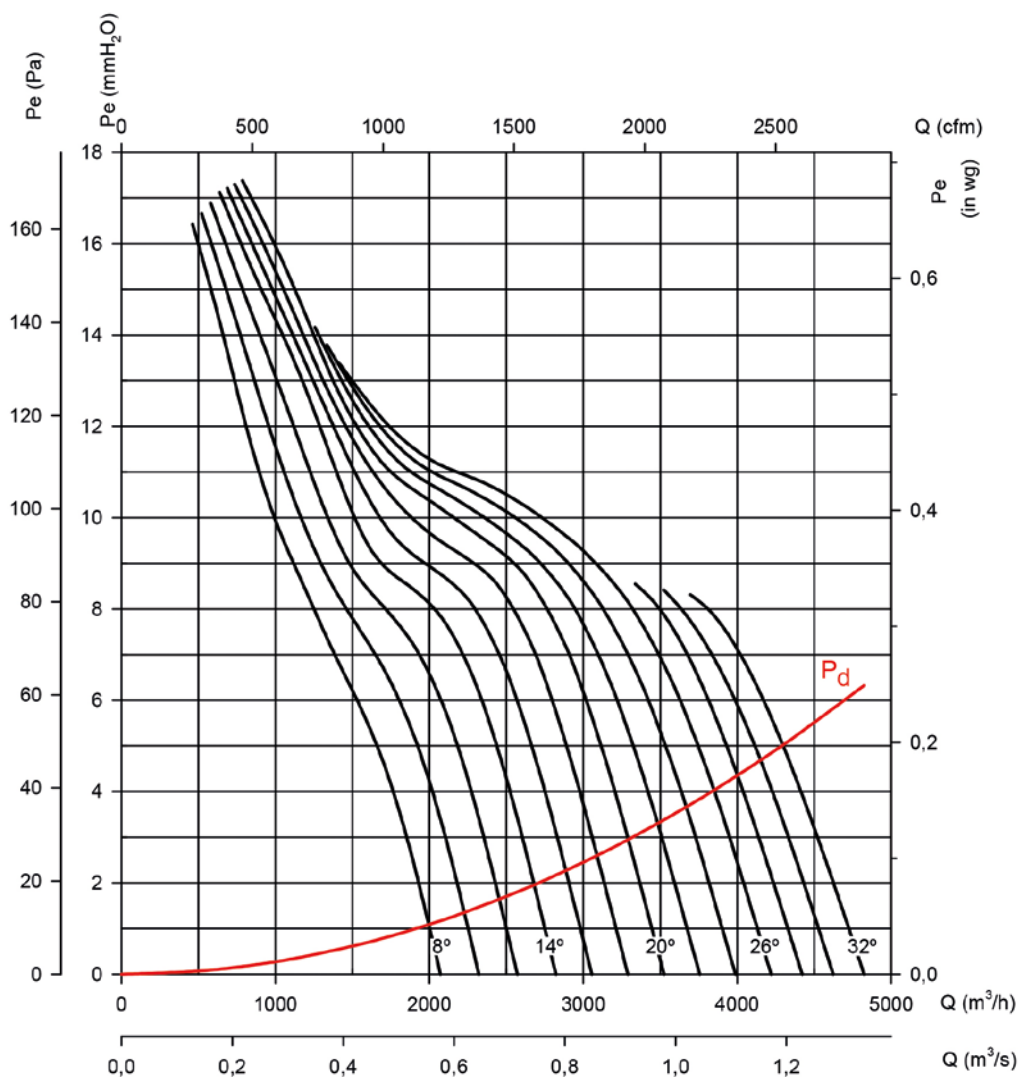

Curve caratteristiche

Q= Portata in m³/h, m³/s e cfm

Pe= Pressione statica in mmH₂O, Pa e inwg

Diametro girante in cm: 40

Numero di poli del motore: 6

Numero di pale: 6

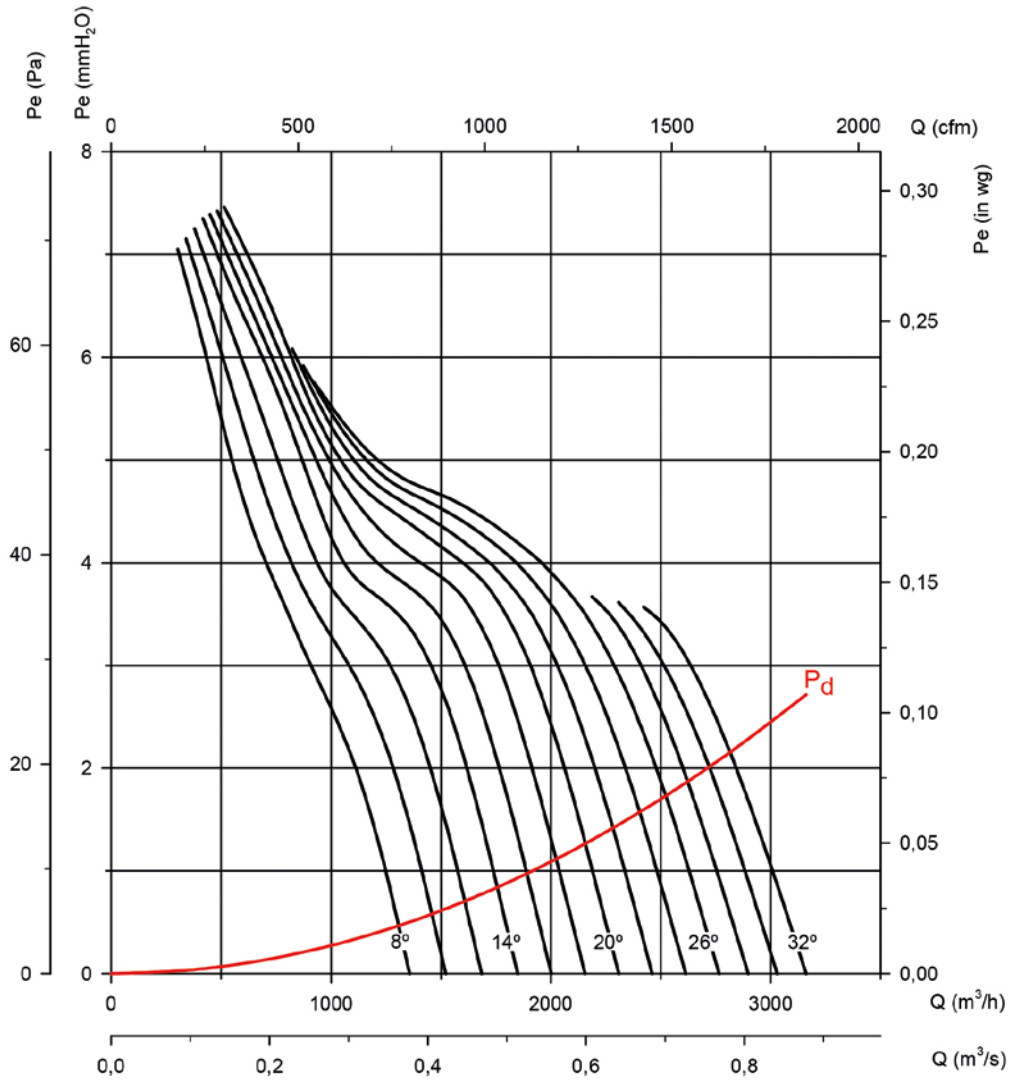

Potenza assorbita

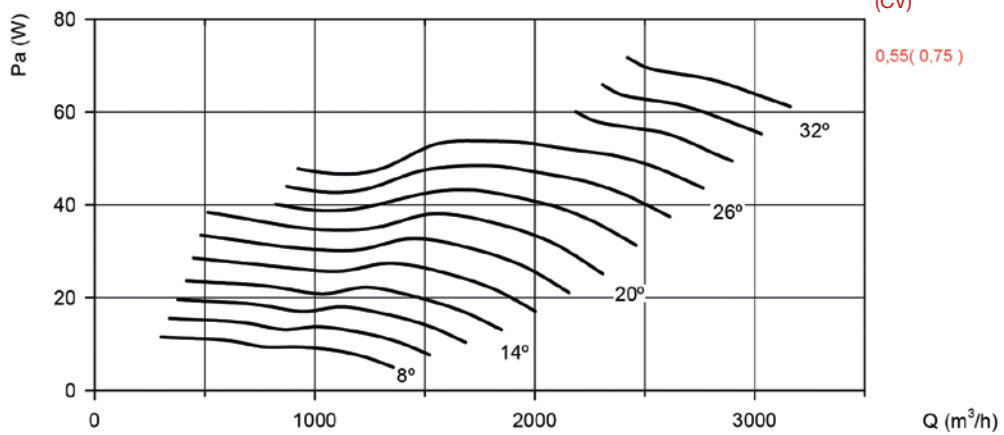

Potenza motore consigliata kW (CV)

0,55(0,75)

Curve caratteristiche

Q= Portata in m³/h, m³/s e cfm

Pe= Pressione statica in mmH₂O, Pa e inwg

Diametro girante in cm: 45

Numero di poli del motore: 2

Numero di pale: 6

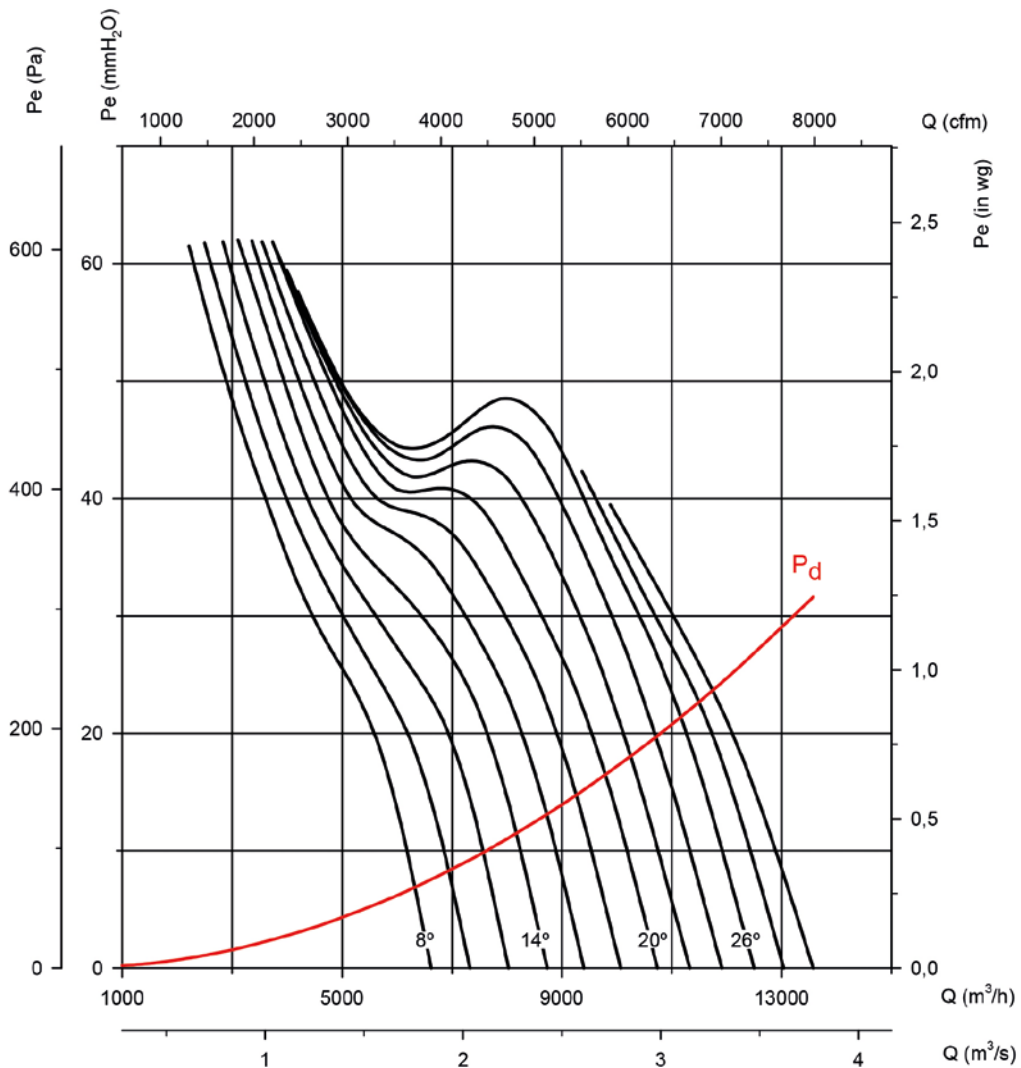

Potenza assorbita

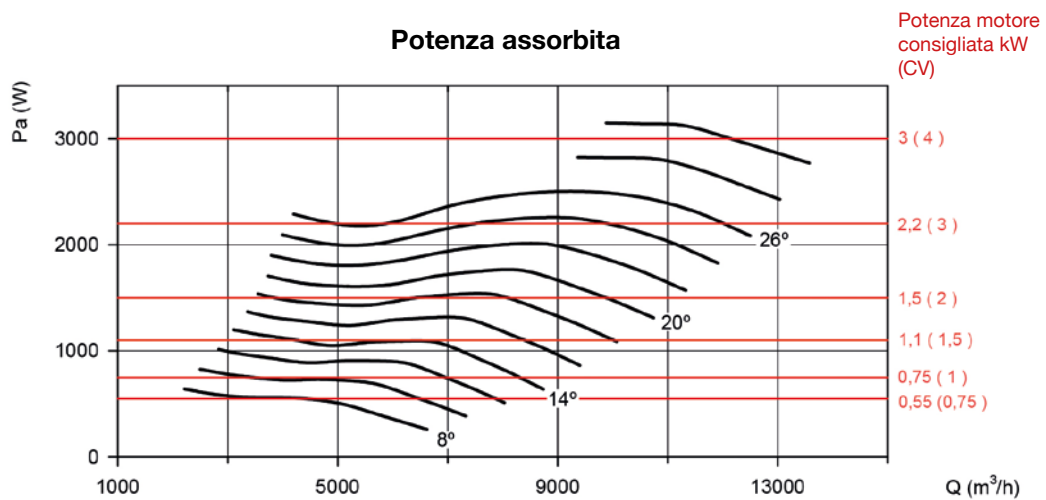

Potenza motore
consigliata kW
(CV)

Curve caratteristiche

Q= Portata in m³/h, m³/s e cfm

Pe= Pressione statica in mmH₂O, Pa e inwg

Diametro girante in cm: 45

Numero di poli del motore: 4

Numero di pale: 6

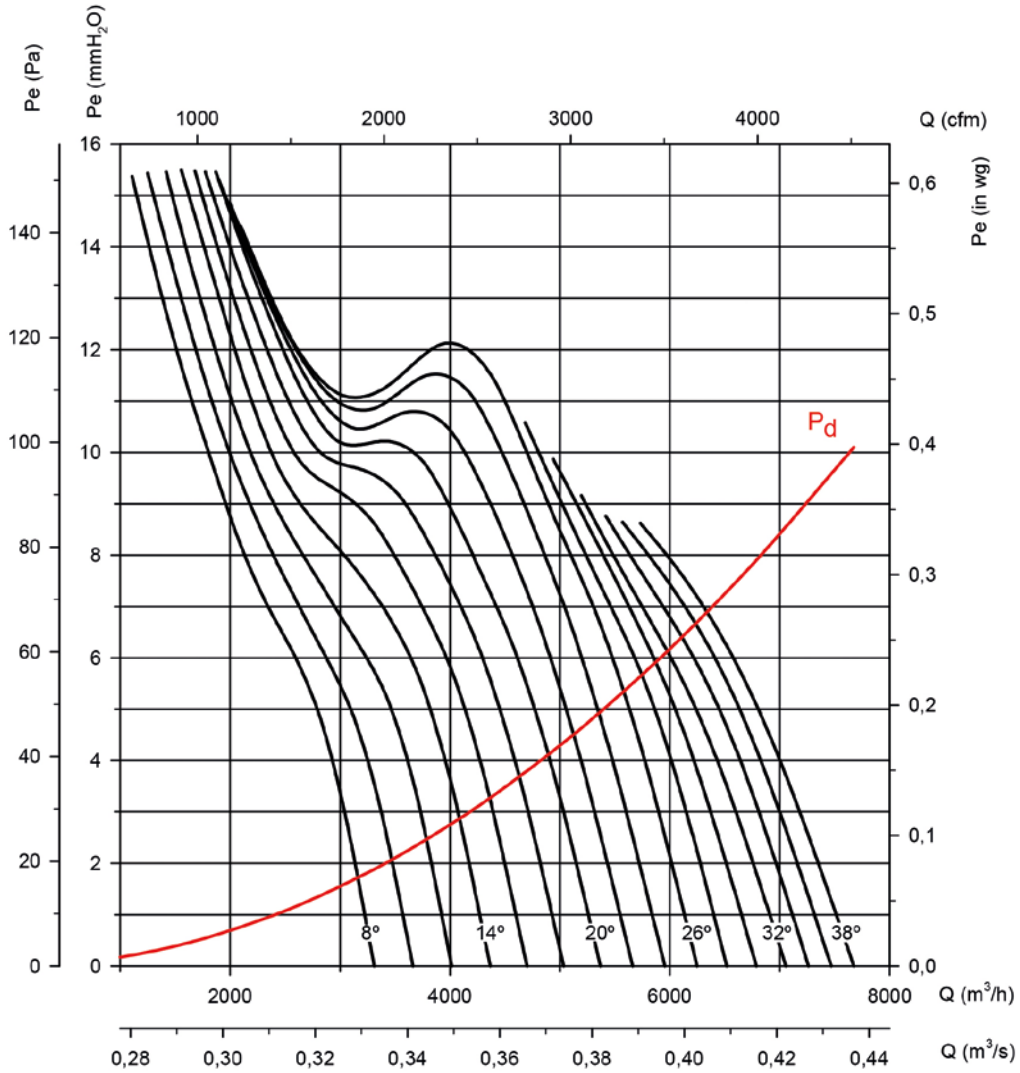

Potenza assorbita

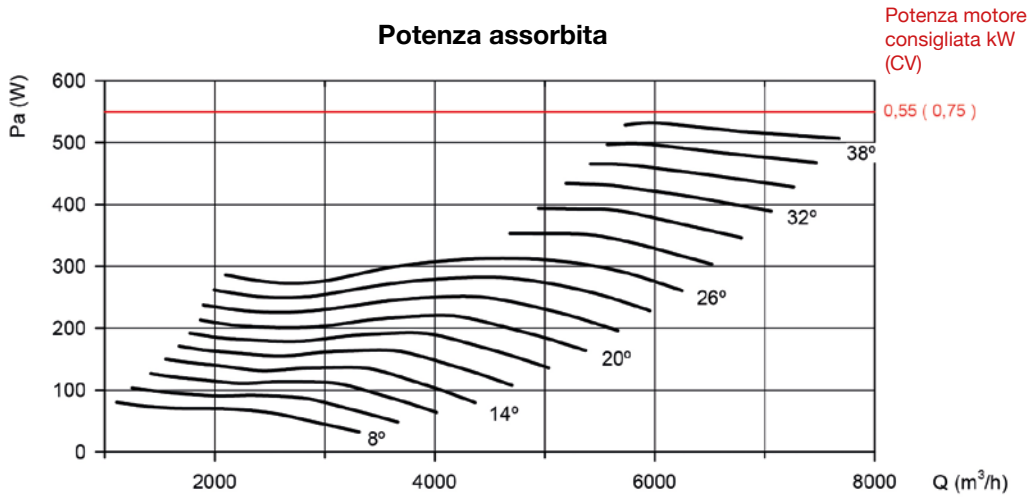

Curve caratteristiche

Q= Portata in m³/h, m³/s e cfm

Pe= Pressione statica in mmH₂O, Pa e inwg

Diametro girante in cm: 45

Numero di poli del motore: 6

Numero di pale: 6

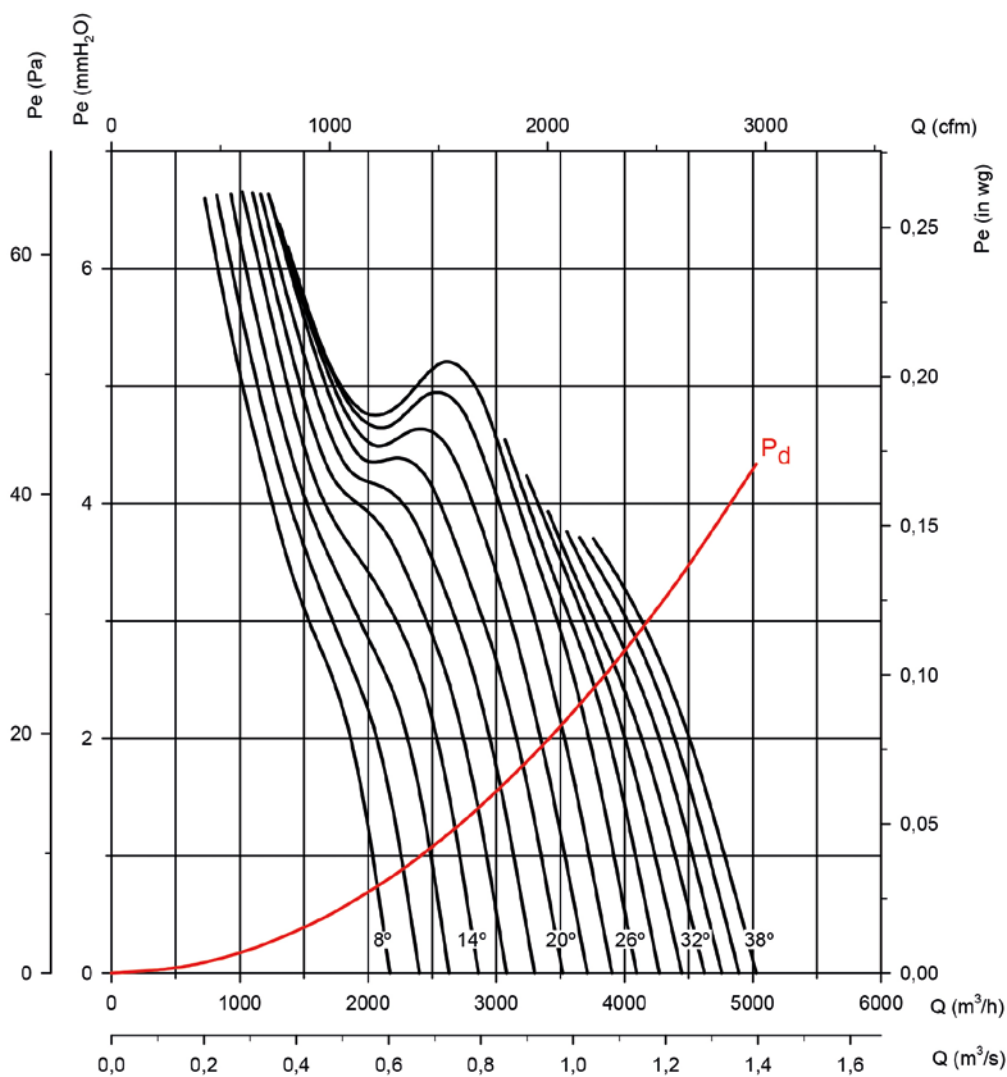

Potenza assorbita

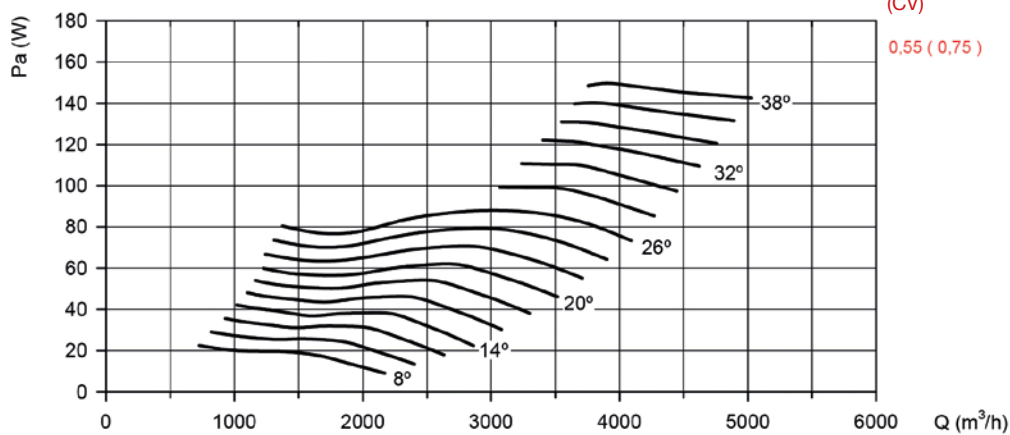

Potenza motore
consigliata kW
(CV)

0,55 (0,75)

Curve caratteristiche

Q= Portata in m³/h, m³/s e cfm

Pe= Pressione statica in mmH₂O, Pa e inwg

Diametro girante in cm: 50

Numero di poli del motore: 4

Numero di pale: 6

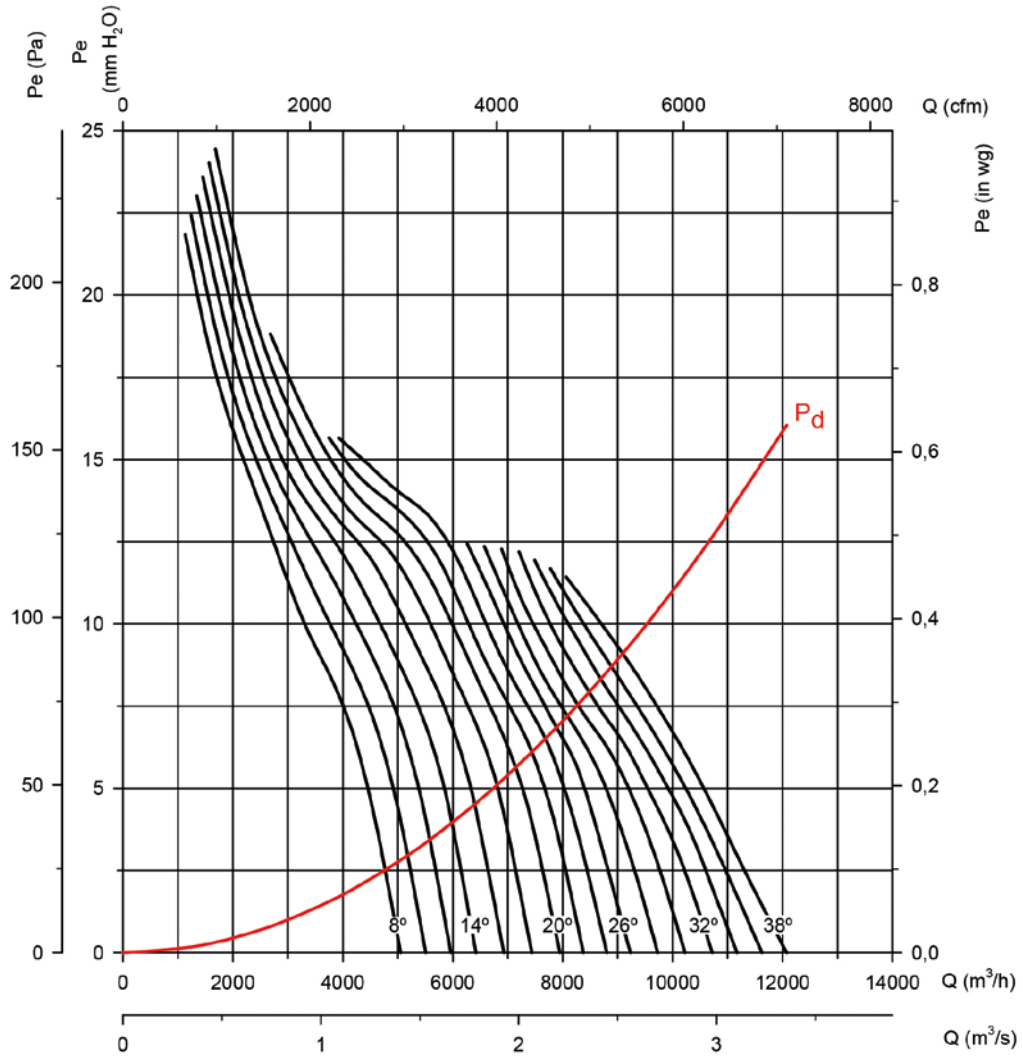

Potenza assorbita

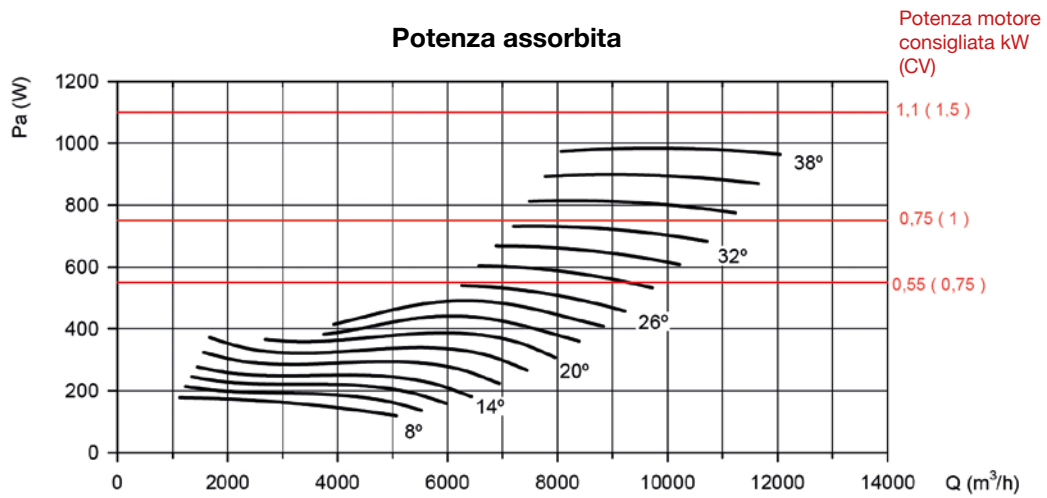

Curve caratteristiche

Q= Portata in m³/h, m³/s e cfm

Pe= Pressione statica in mmH₂O, Pa e inwg

Diametro girante in cm: 50

Numero di poli del motore: 6

Numero di pale: 6

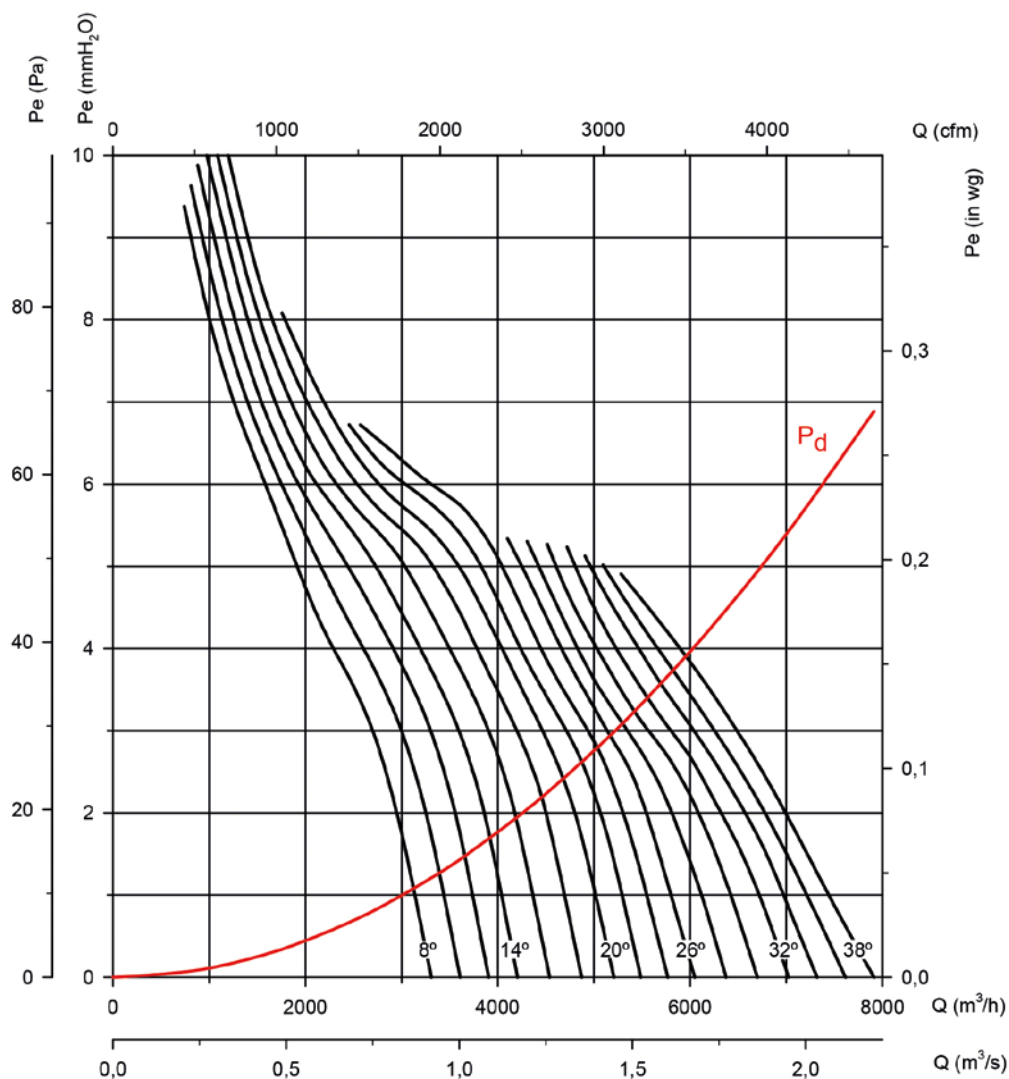

Potenza assorbita

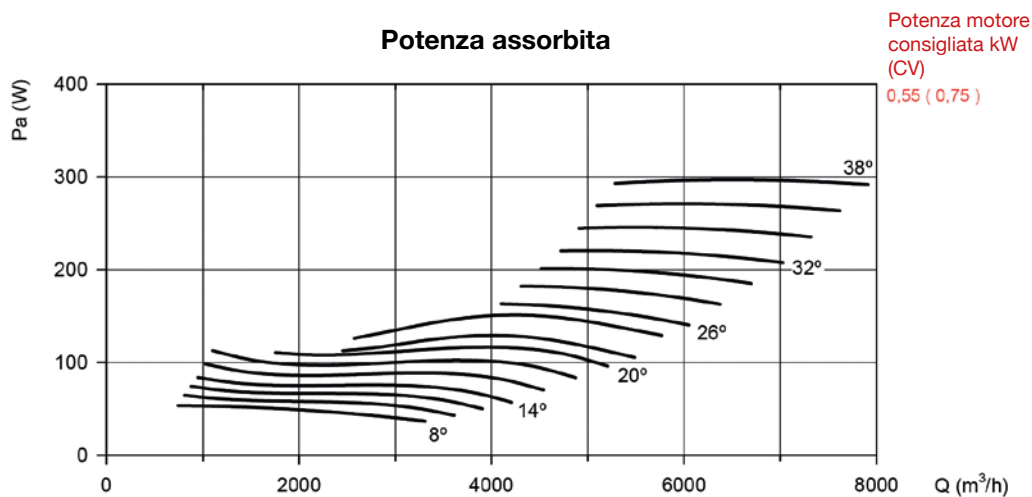

Curve caratteristiche

Q= Portata in m³/h, m³/s e cfm

Pe= Pressione statica in mmH₂O, Pa e inwg

Diametro girante in cm: 56

Numero di poli del motore: 4

Numero di pale: 6

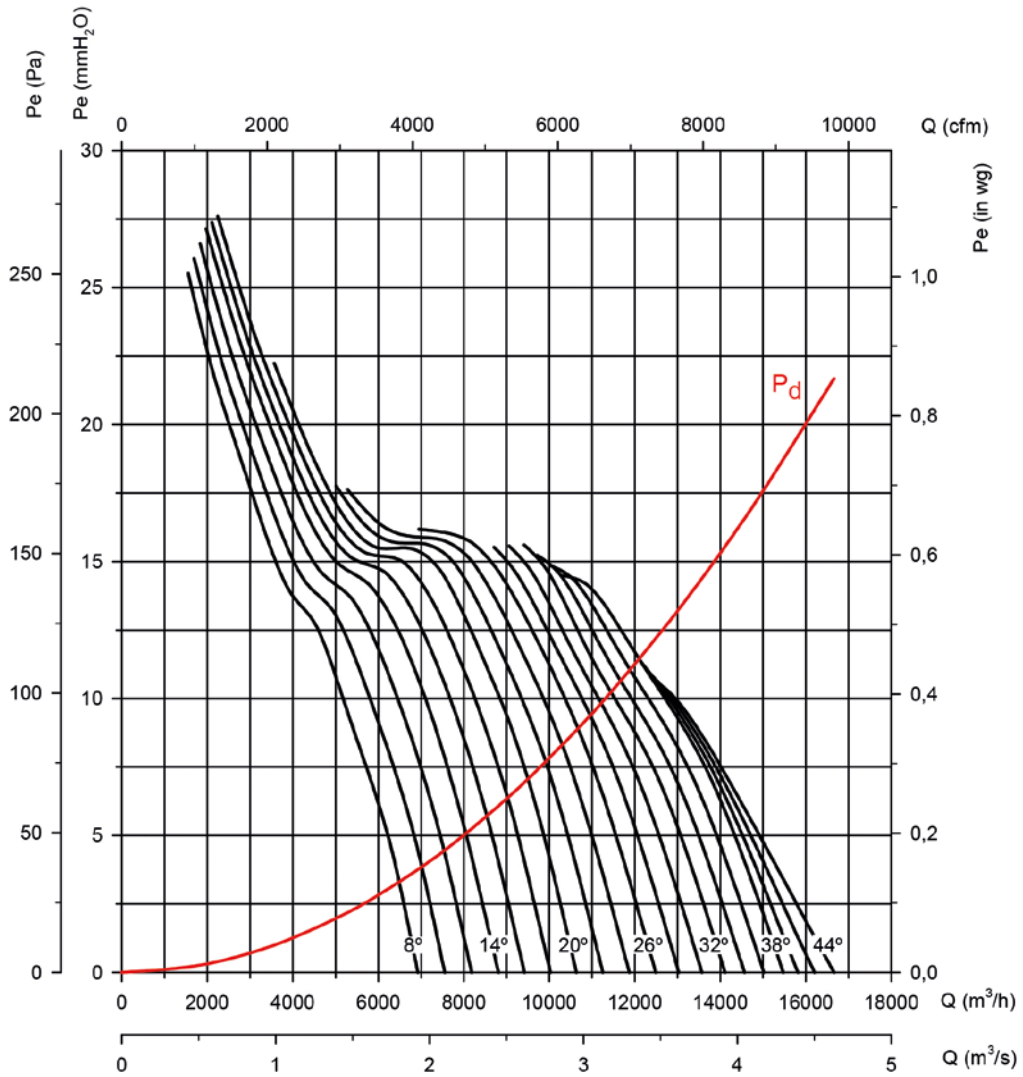

Potenza assorbita

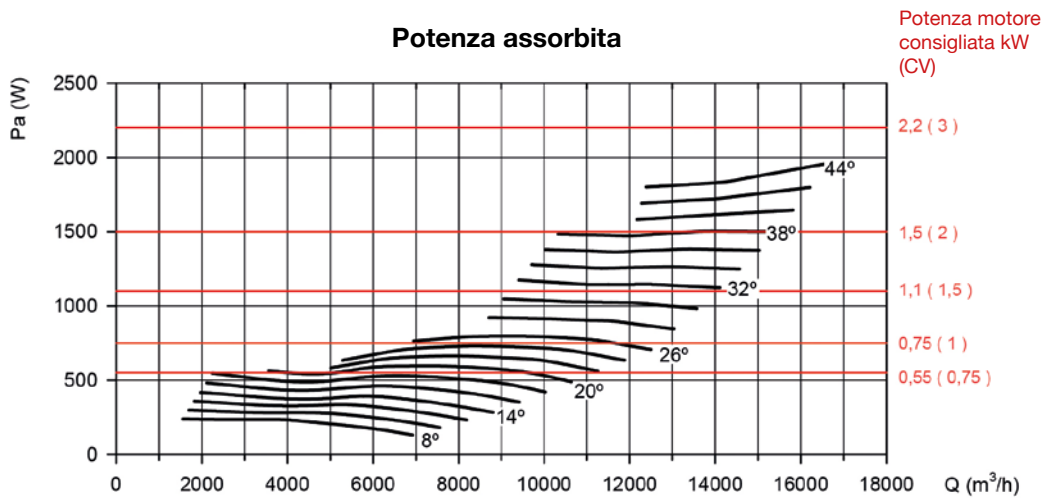

Curve caratteristiche

Q= Portata in m³/h, m³/s e cfm

Pe= Pressione statica in mmH₂O, Pa e inwg

Diametro girante in cm: 56

Numero di poli del motore: 6

Numero di pale: 6

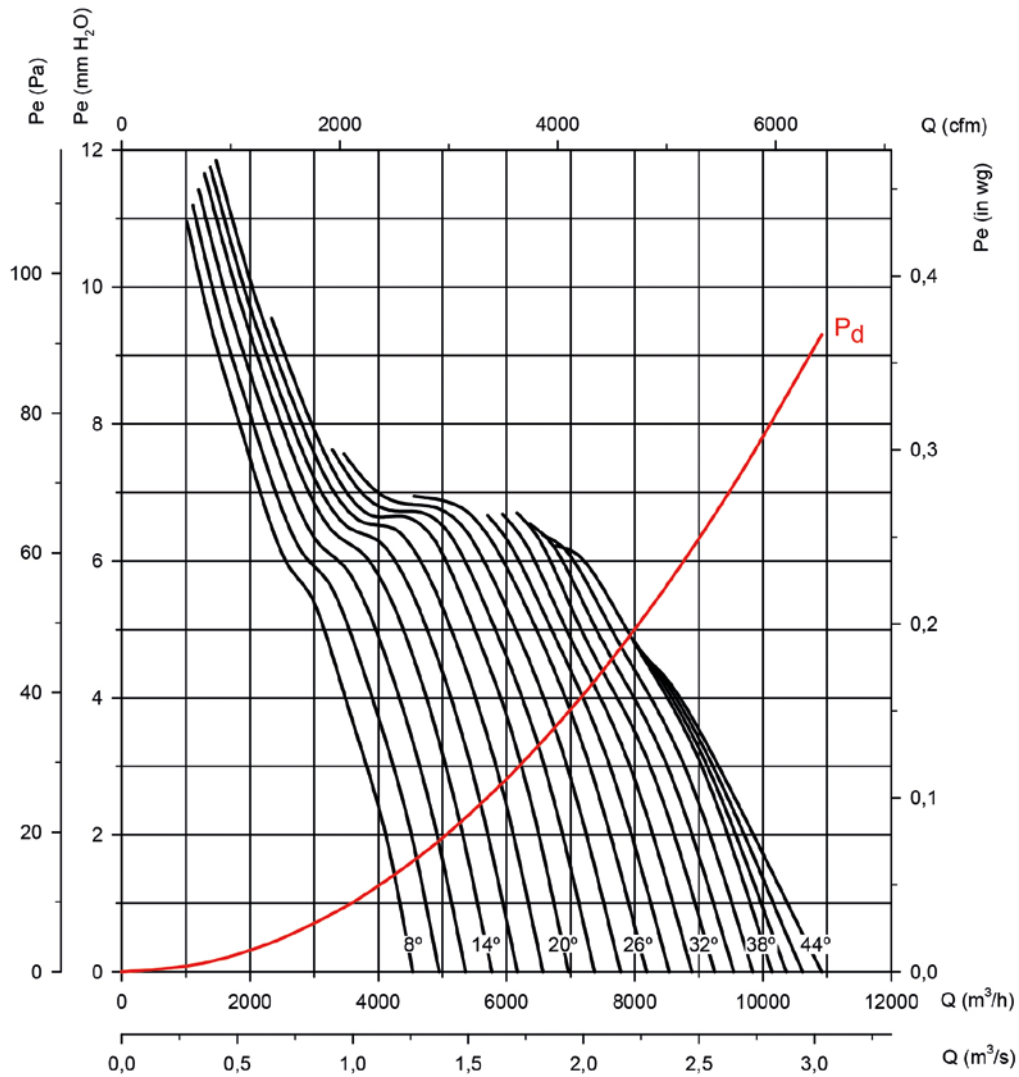

Potenza assorbita

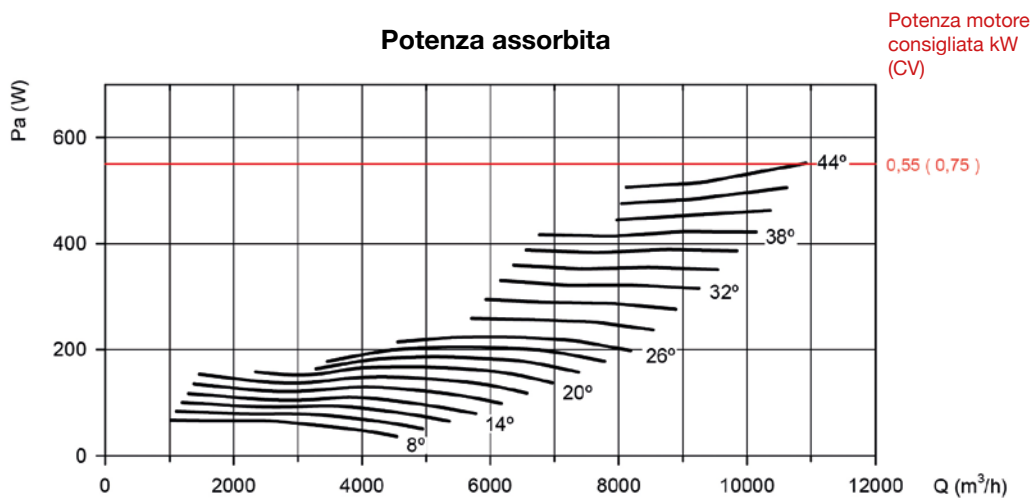

Curve caratteristiche

Q= Portata in m³/h, m³/s e cfm

Pe= Pressione statica in mmH₂O, Pa e inwg

Diametro girante in cm: 63

Numero di poli del motore: 4

Numero di pale: 6

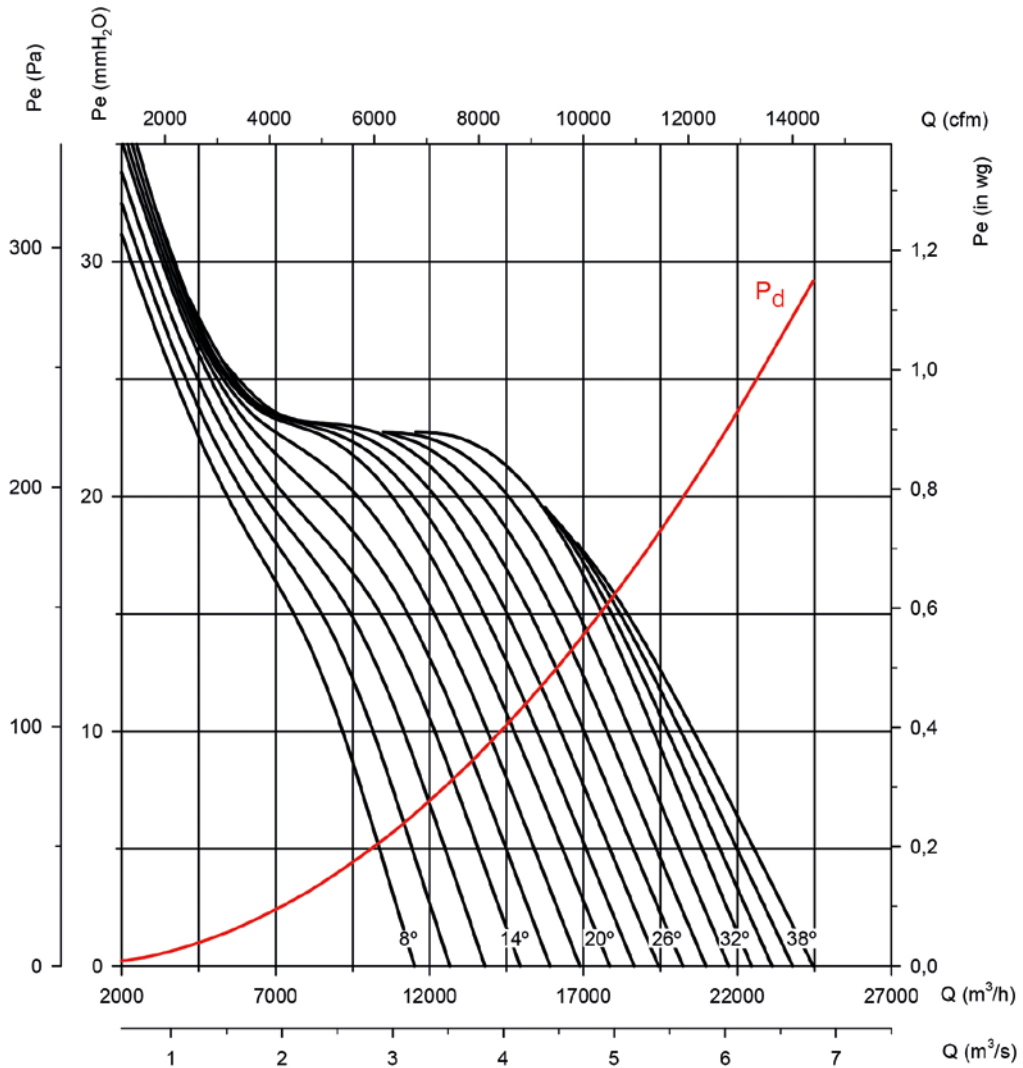

Potenza assorbita

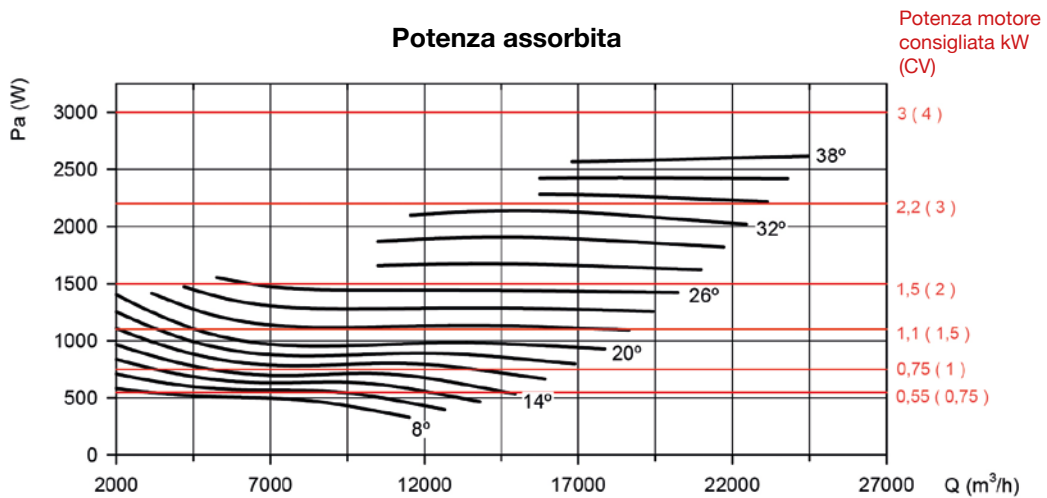

Curve caratteristiche

Q= Portata in m³/h, m³/s e cfm

Pe= Pressione statica in mmH₂O, Pa e inwg

Diametro girante in cm: 63

Numero di poli del motore: 6

Numero di pale: 6

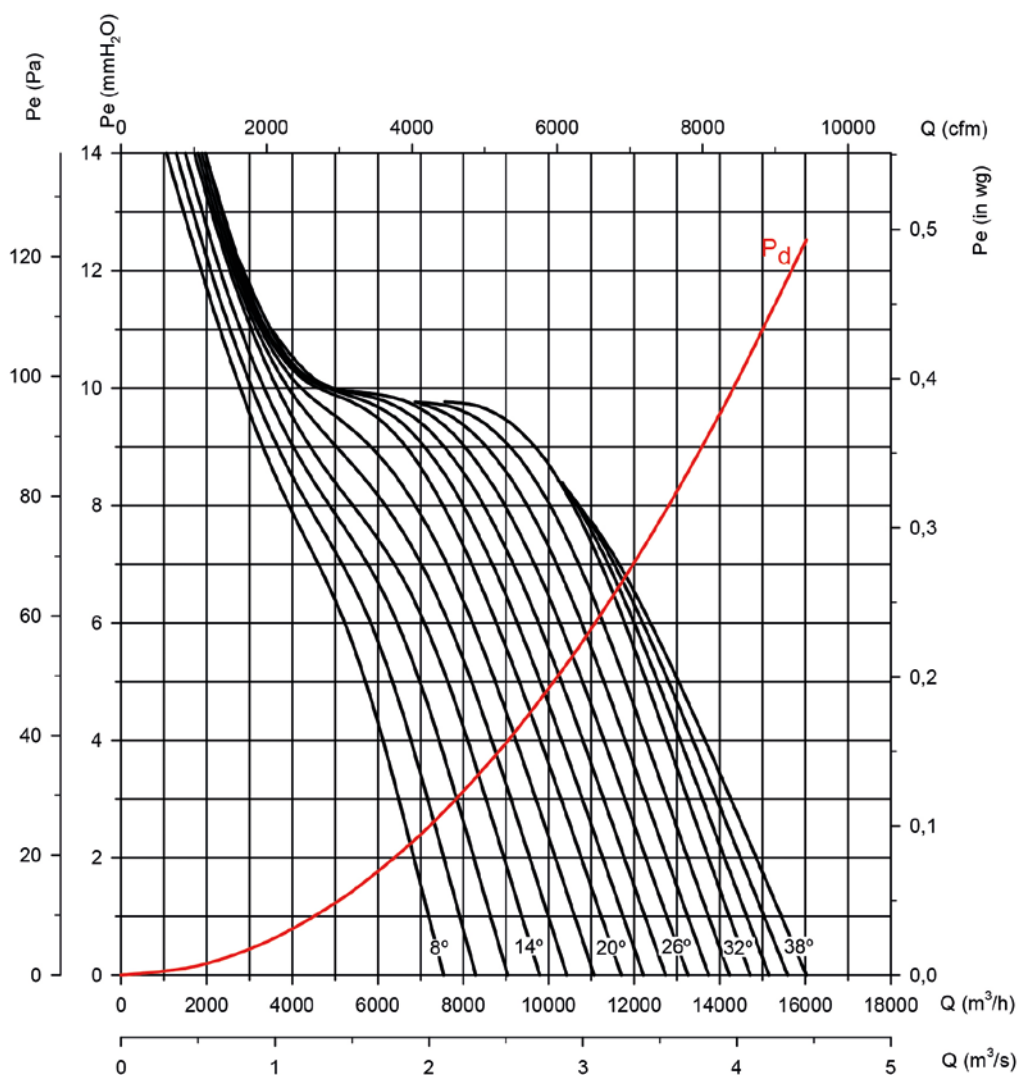

Potenza assorbita

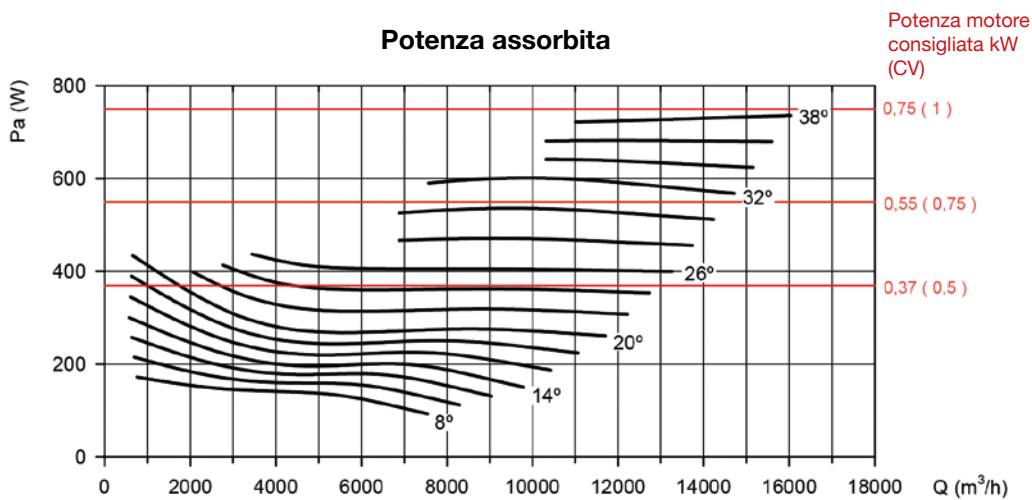

Curve caratteristiche

Q= Portata in m³/h, m³/s e cfm

Pe= Pressione statica in mmH₂O, Pa e inwg

Diametro girante in cm: 71

Numero di poli del motore: 4

Numero di pale: 6

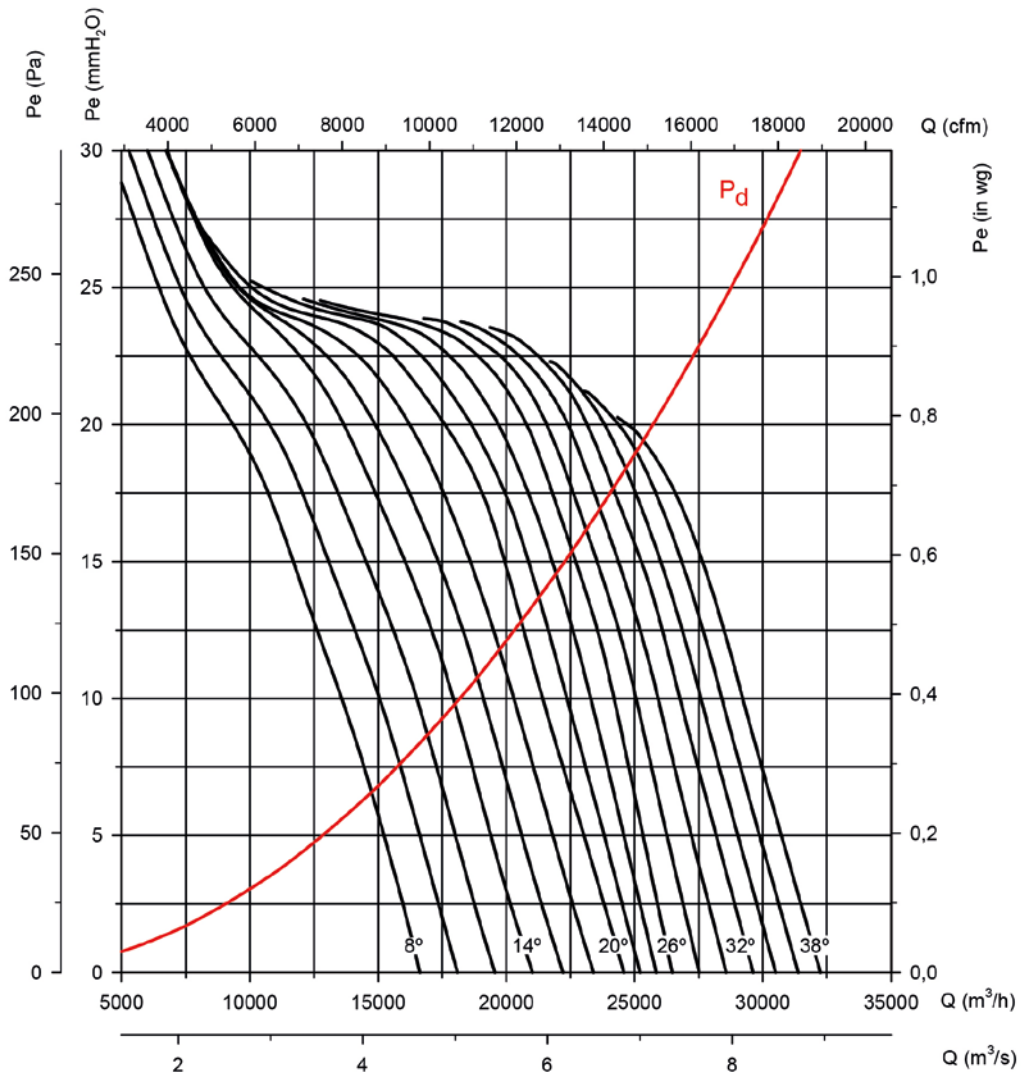

Potenza assorbita

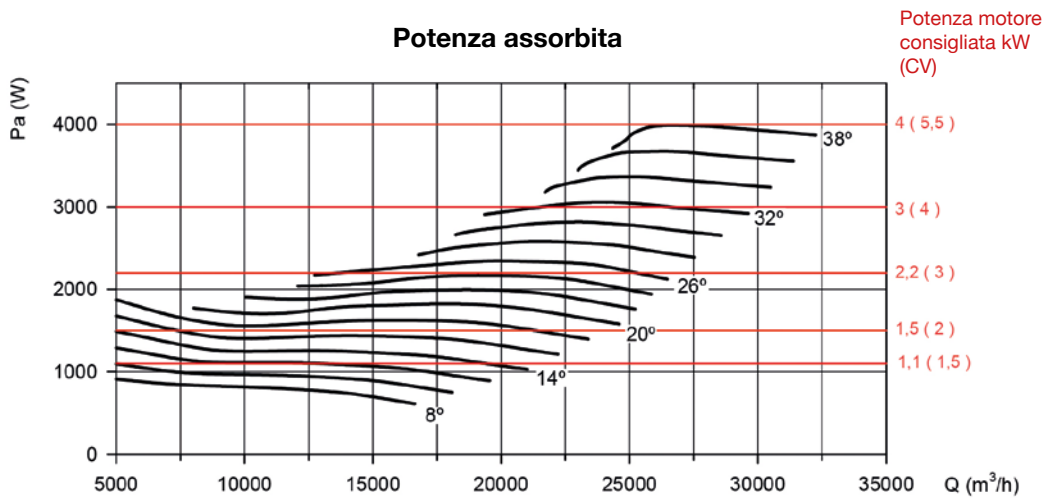

Curve caratteristiche

Q= Portata in m³/h, m³/s e cfm

Pe= Pressione statica in mmH₂O, Pa e inwg

Diametro girante in cm: 71

Numero di poli del motore: 6

Numero di pale: 6

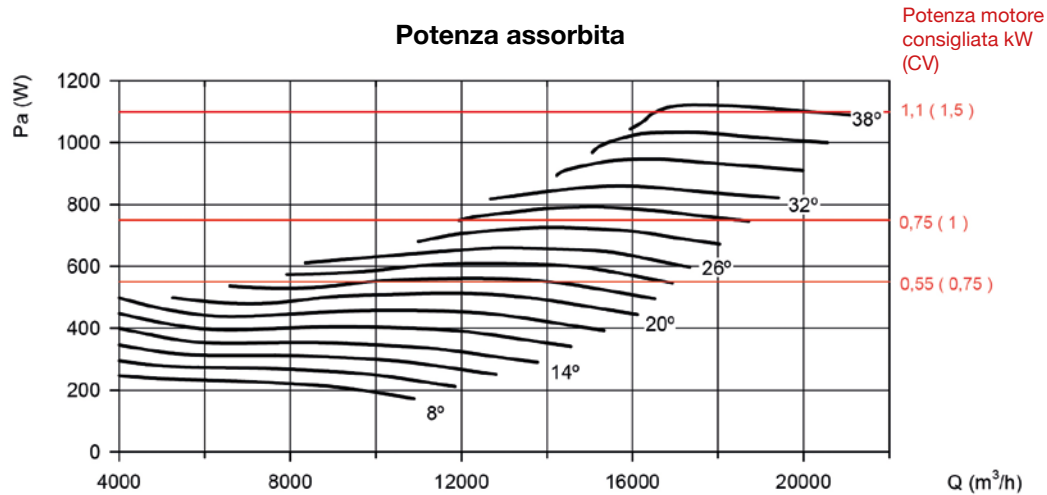
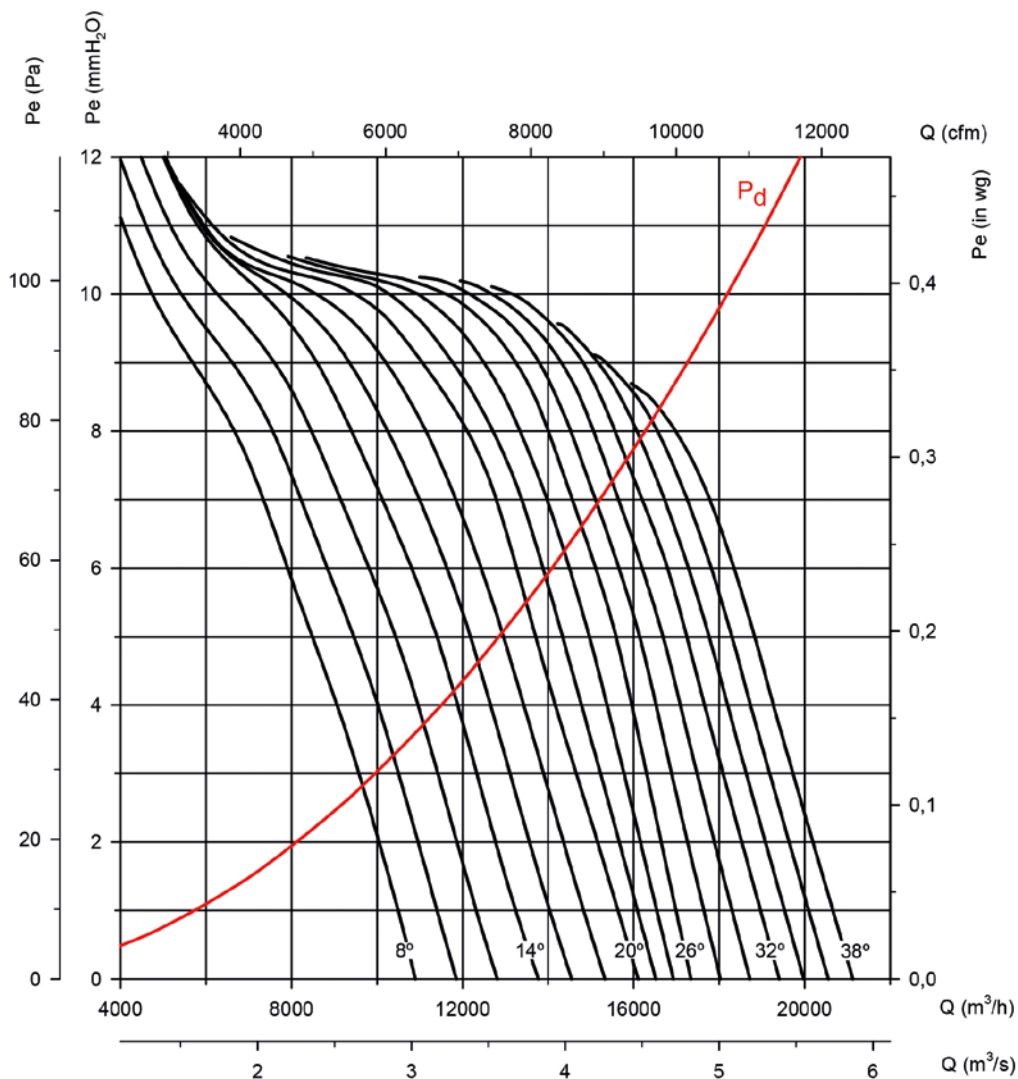

Curve caratteristiche

Q= Portata in m³/h, m³/s e cfm

Pe= Pressione statica in mmH₂O, Pa e inwg

Diametro girante in cm: 80

Numero di poli del motore: 4

Numero di pale: 6

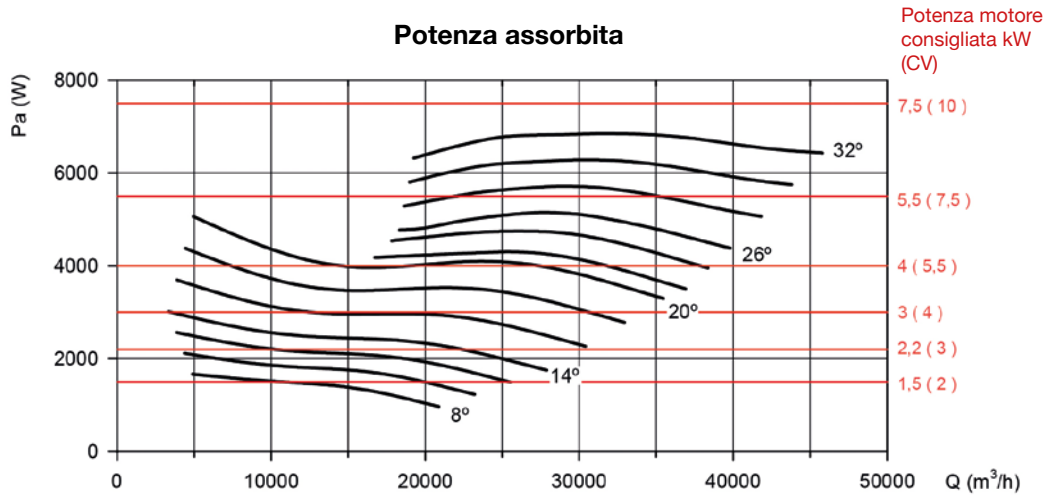
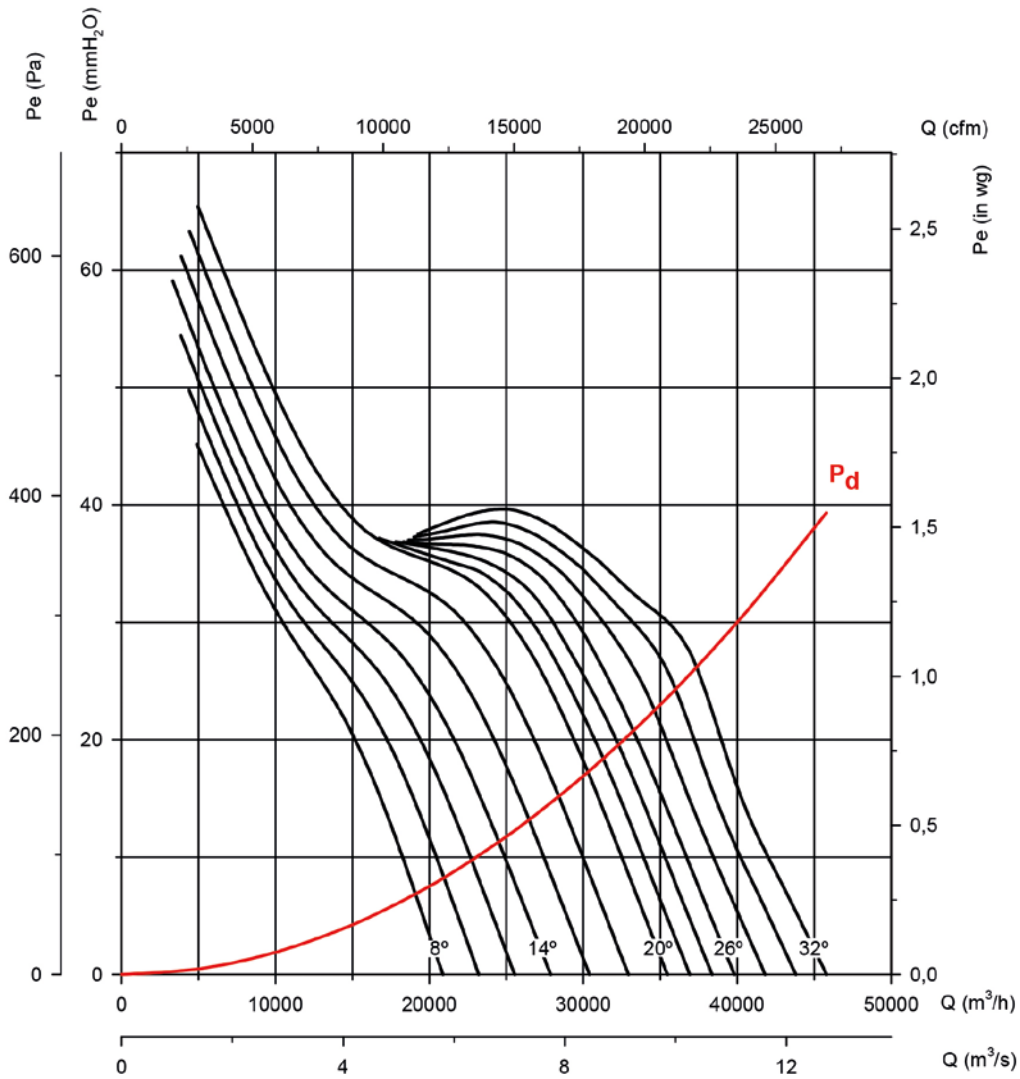

Curve caratteristiche

Q= Portata in m³/h, m³/s e cfm

Pe= Pressione statica in mmH₂O, Pa e inwg

Diametro girante in cm: 80

Numero di poli del motore: 6

Numero di pale: 6

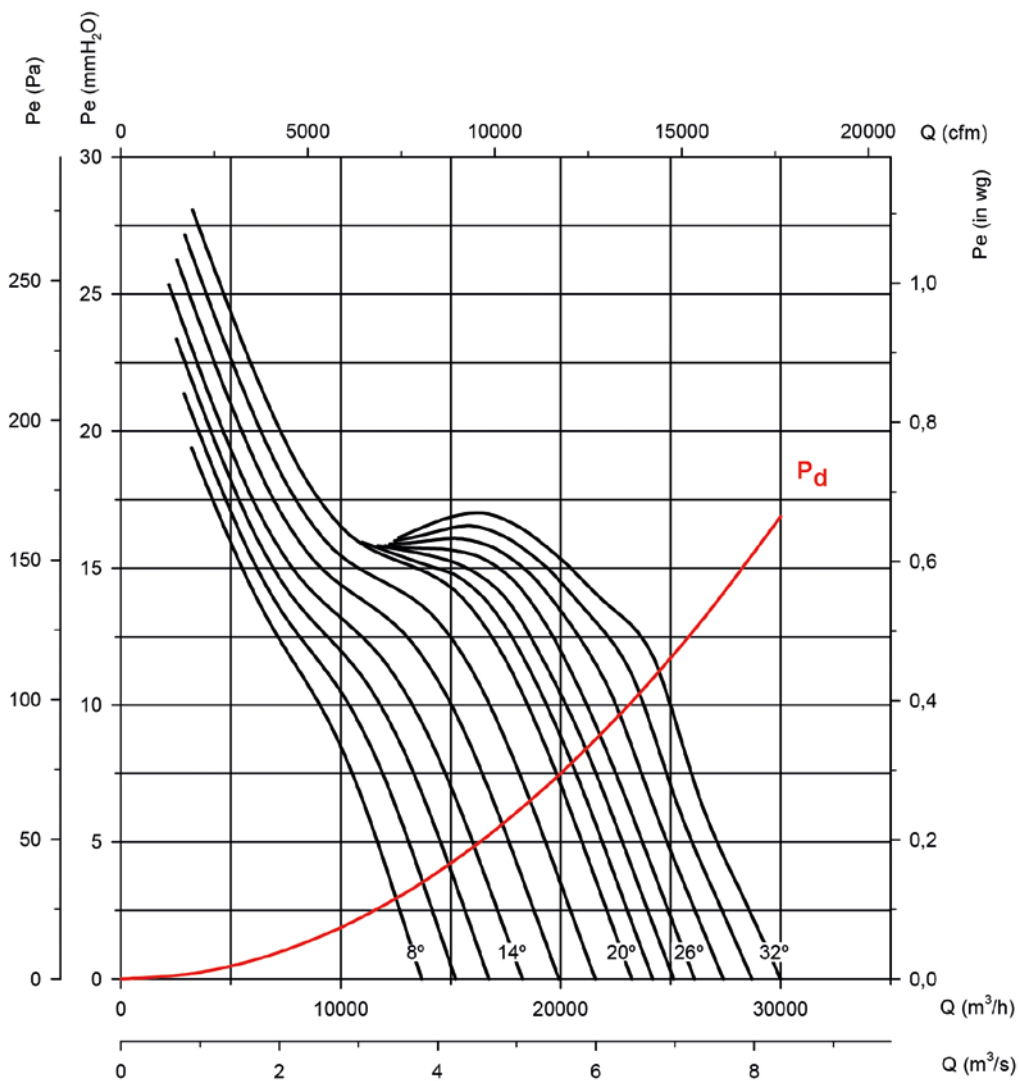

Potenza assorbita

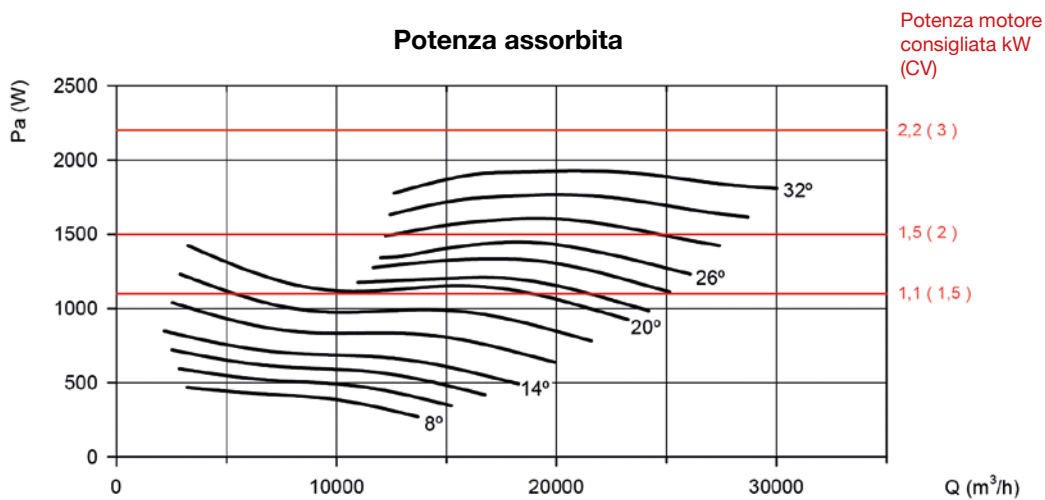

Curve caratteristiche

Q= Portata in m³/h, m³/s e cfm

Pe= Pressione statica in mmH₂O, Pa e inwg

Diametro girante in cm: 80

Numero di poli del motore: 8

Numero di pale: 6

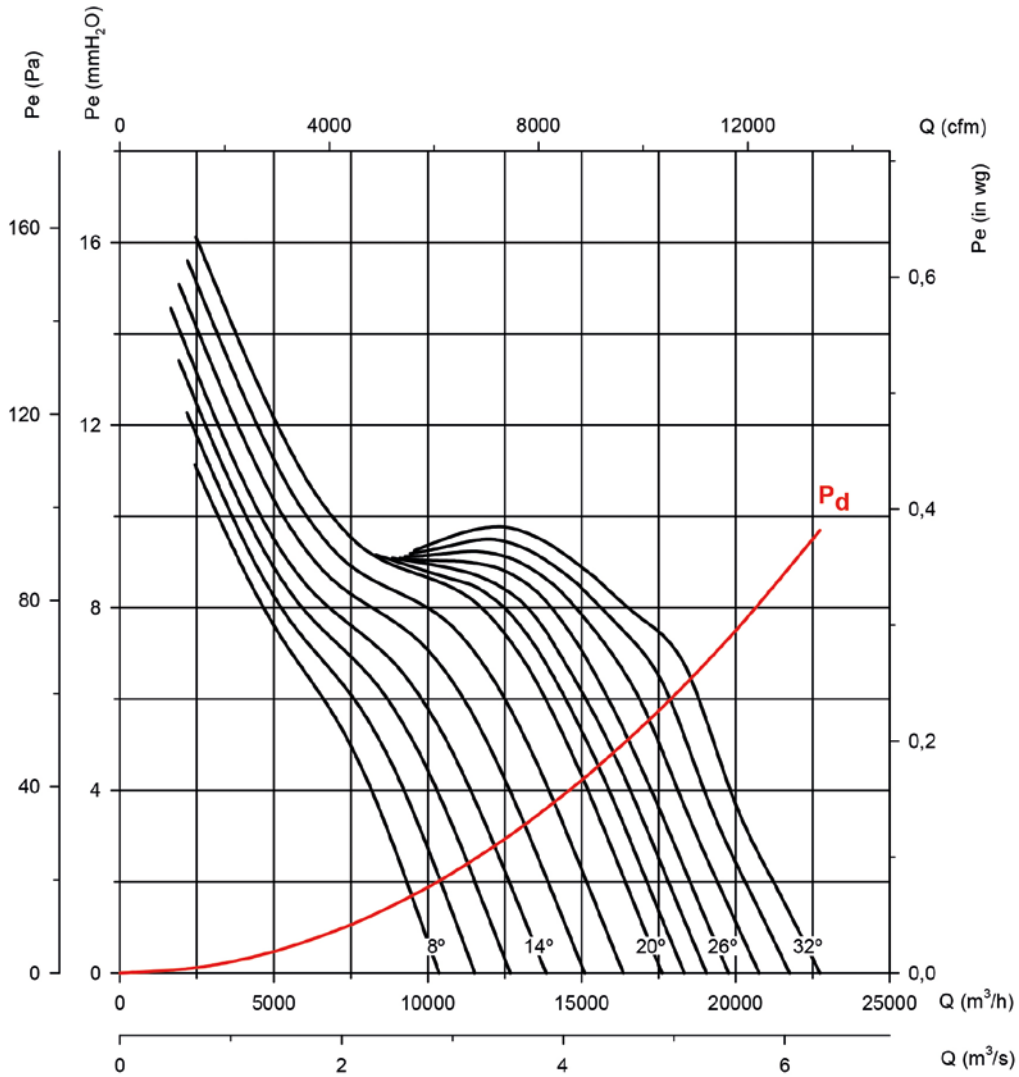

Potenza assorbita

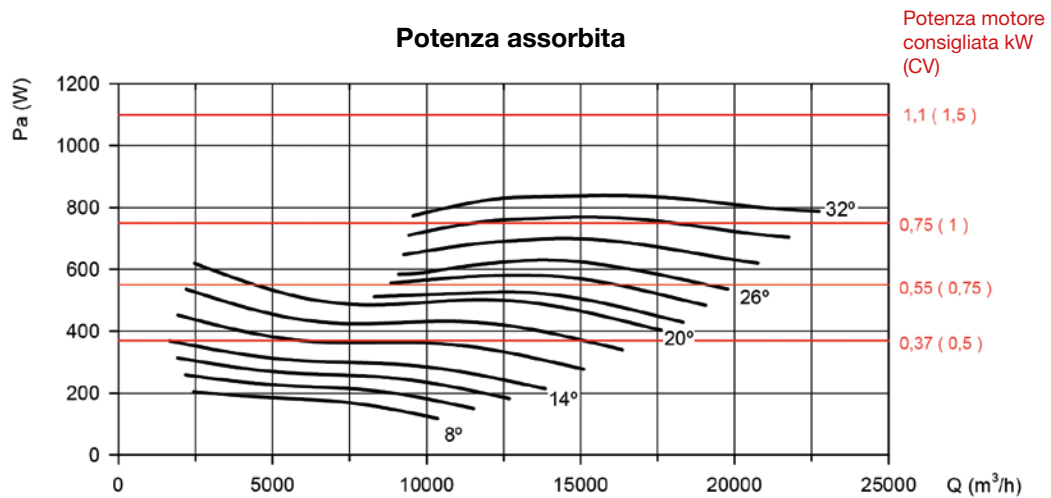

Curve caratteristiche

Q= Portata in m³/h, m³/s e cfm

Pe= Pressione statica in mmH₂O, Pa e inwg

Diametro girante in cm: 90

Numero di poli del motore: 4

Numero di pale: 6

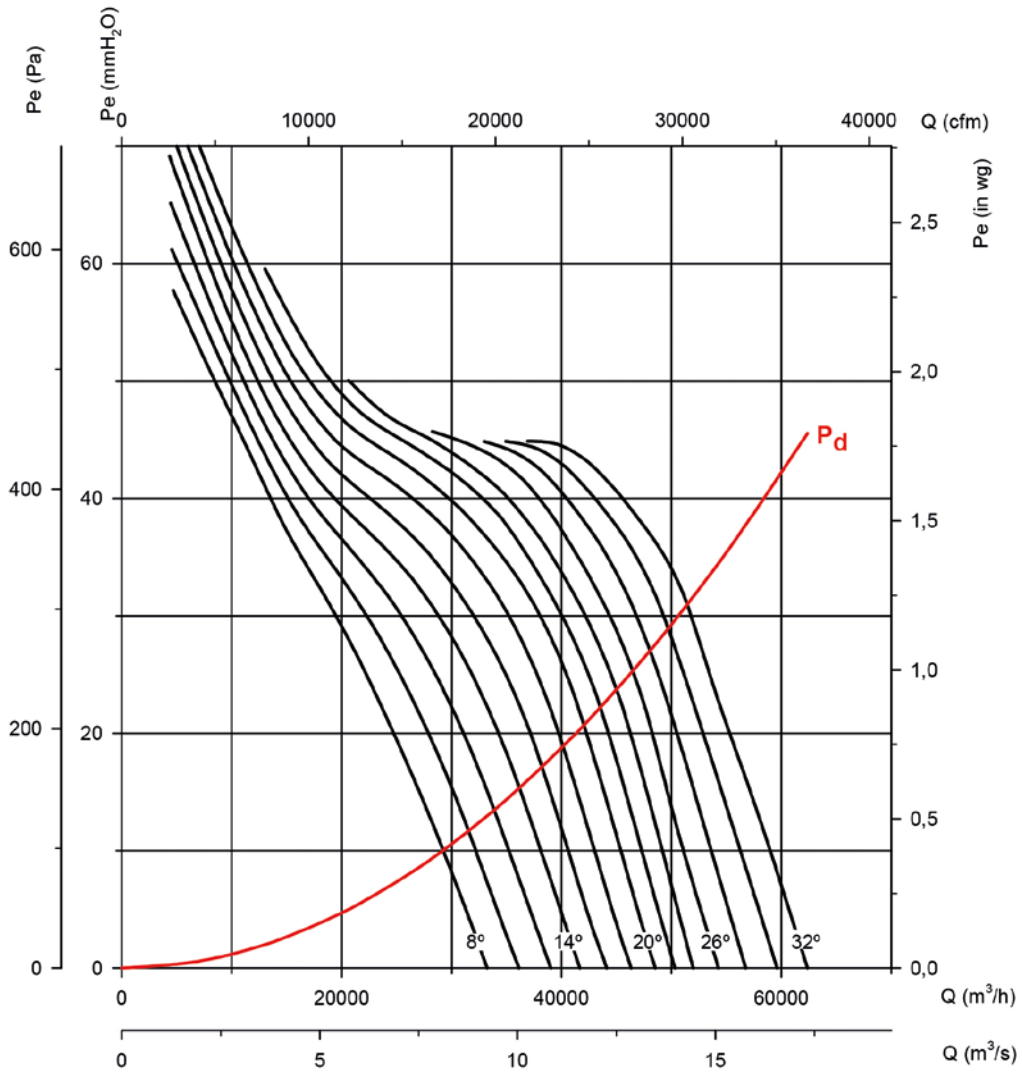

Potenza assorbita

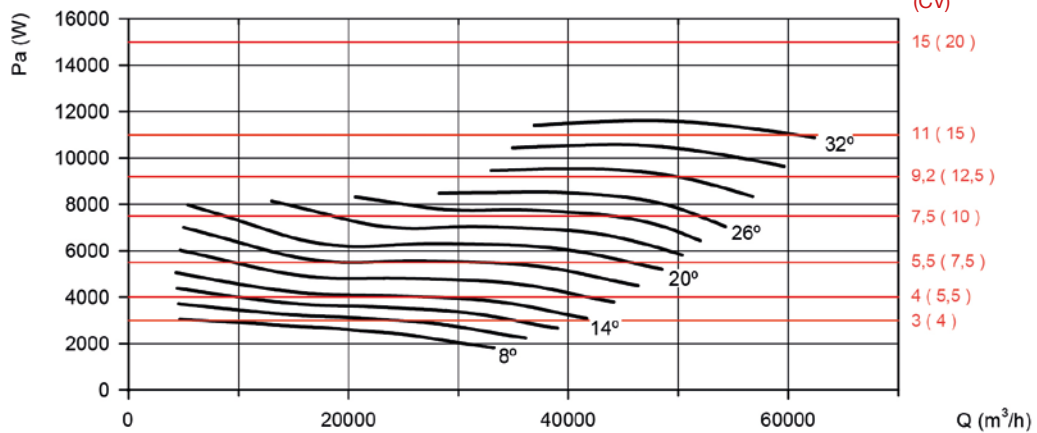

Curve caratteristiche

Q= Portata in m³/h, m³/s e cfm

Pe= Pressione statica in mmH₂O, Pa e inwg

Diametro girante in cm: 90

Numero di poli del motore: 6

Numero di pale: 6

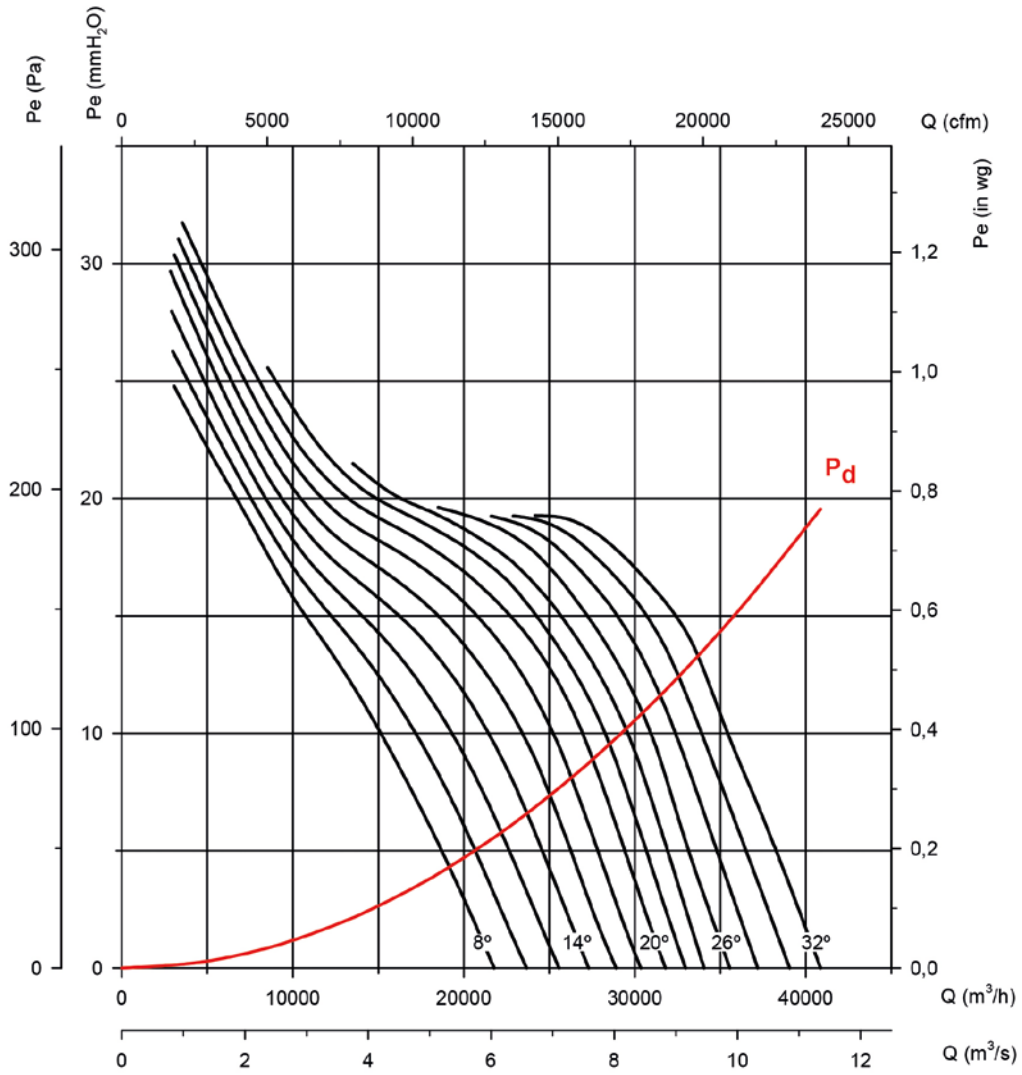

Potenza assorbita

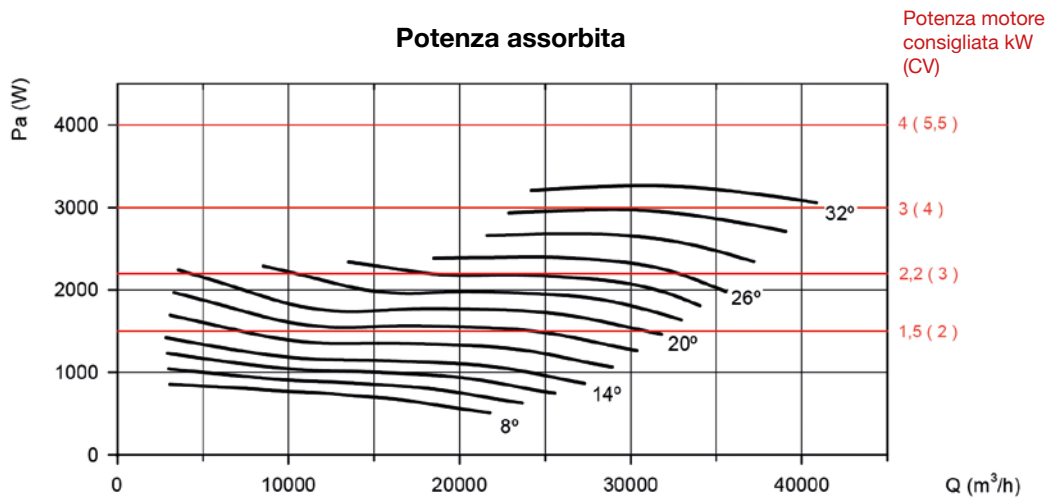

Curve caratteristiche

Q= Portata in m³/h, m³/s e cfm

Pe= Pressione statica in mmH₂O, Pa e inwg

Diametro girante in cm: 90

Numero di poli del motore: 8

Numero di pale: 6

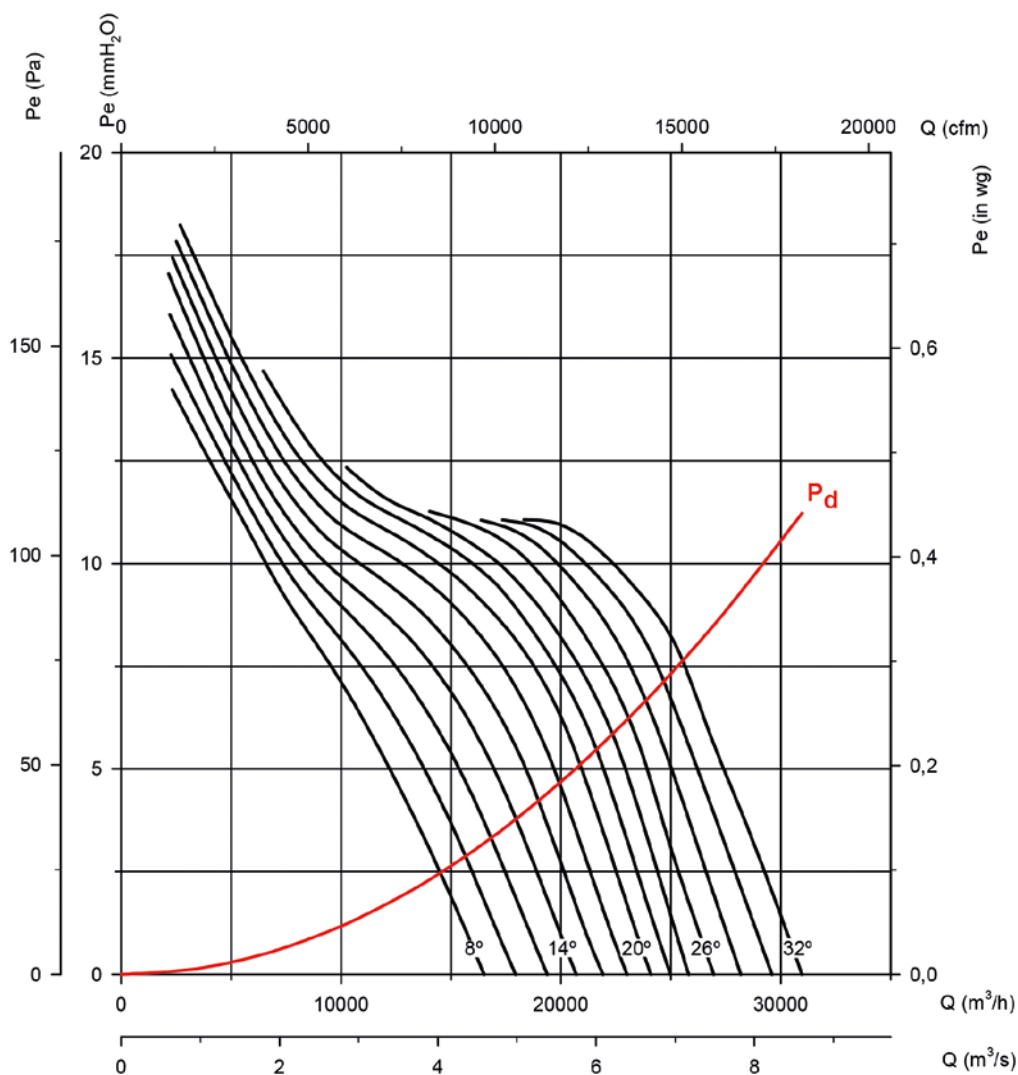

Potenza assorbita

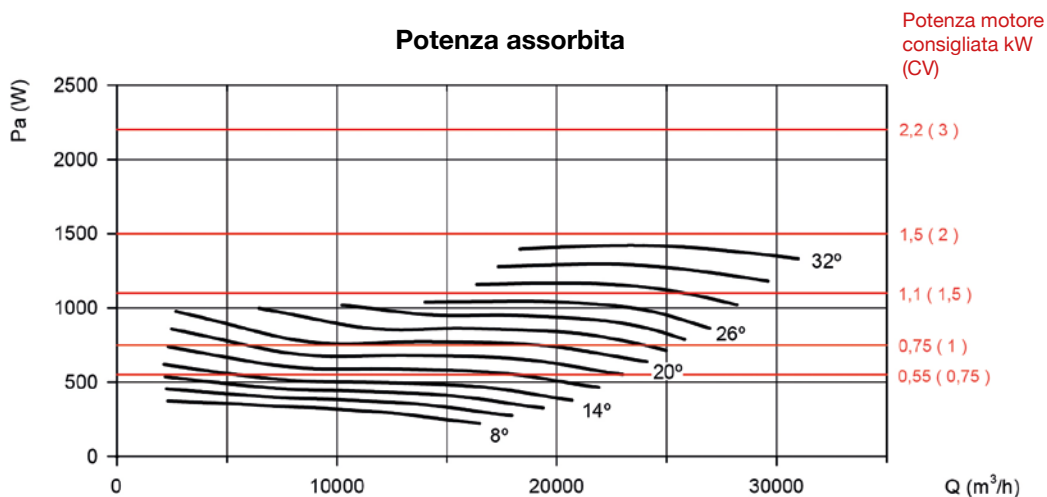

Curve caratteristiche

Q= Portata in m³/h, m³/s e cfm

Pe= Pressione statica in mmH₂O, Pa e inwg

Diametro girante in cm: 100

Numero di poli del motore: 4

Numero di pale: 6

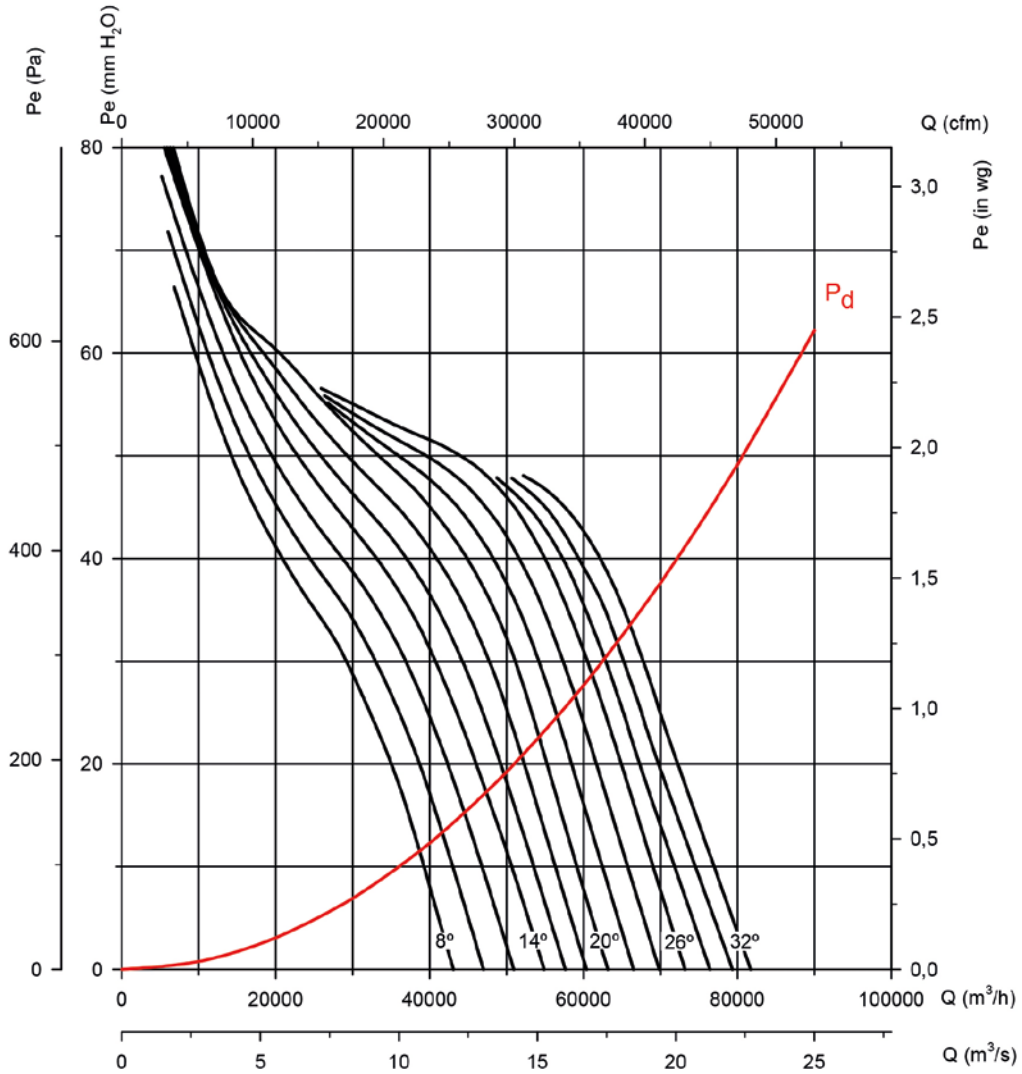

Potenza assorbita

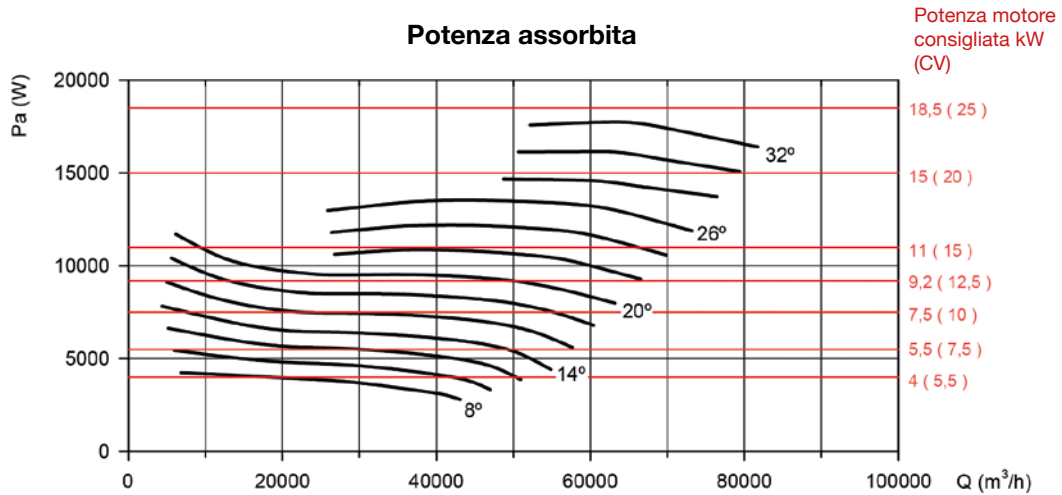

Curve caratteristiche

Q= Portata in m³/h, m³/s e cfm

Pe= Pressione statica in mmH₂O, Pa e inwg

Diametro girante in cm: 100

Numero di poli del motore: 4

Numero di pale: 9

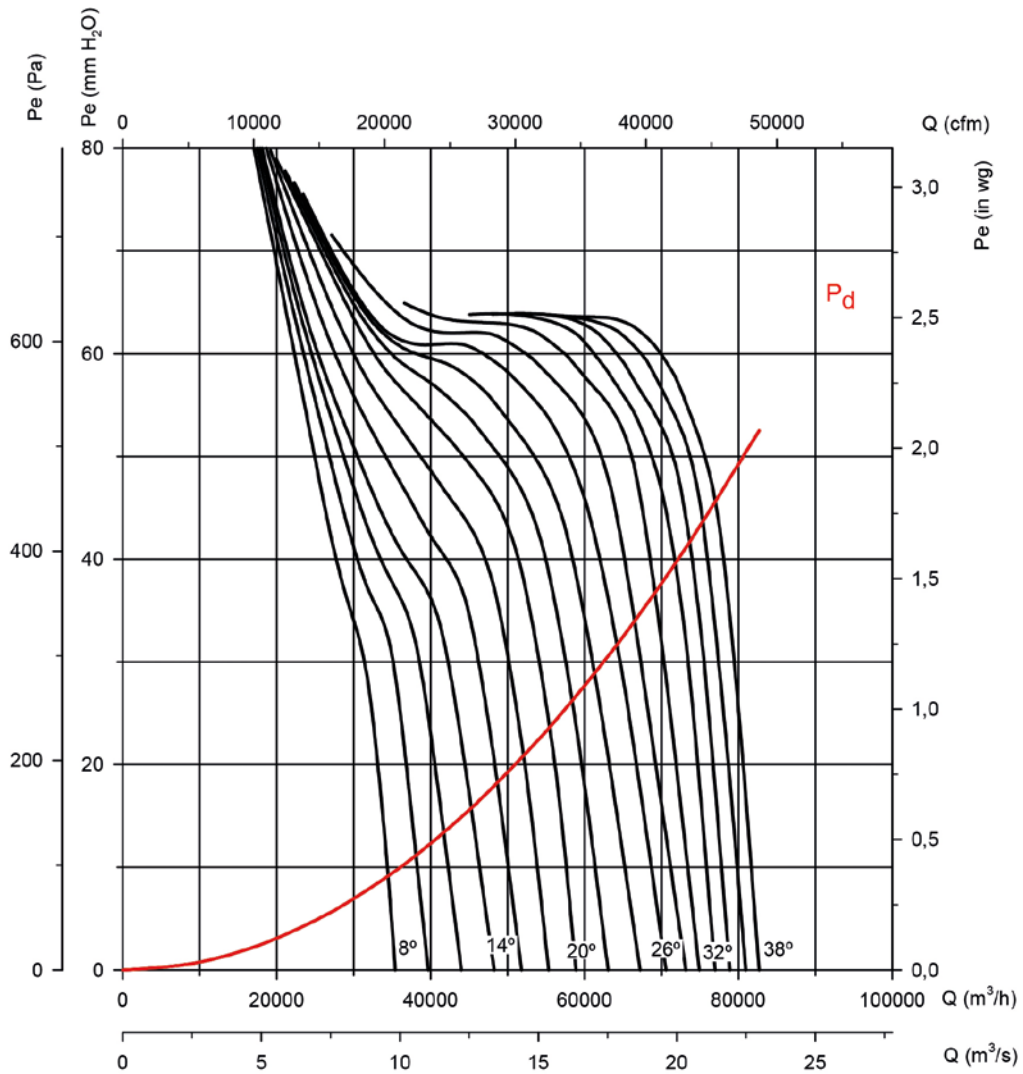

Potenza assorbita

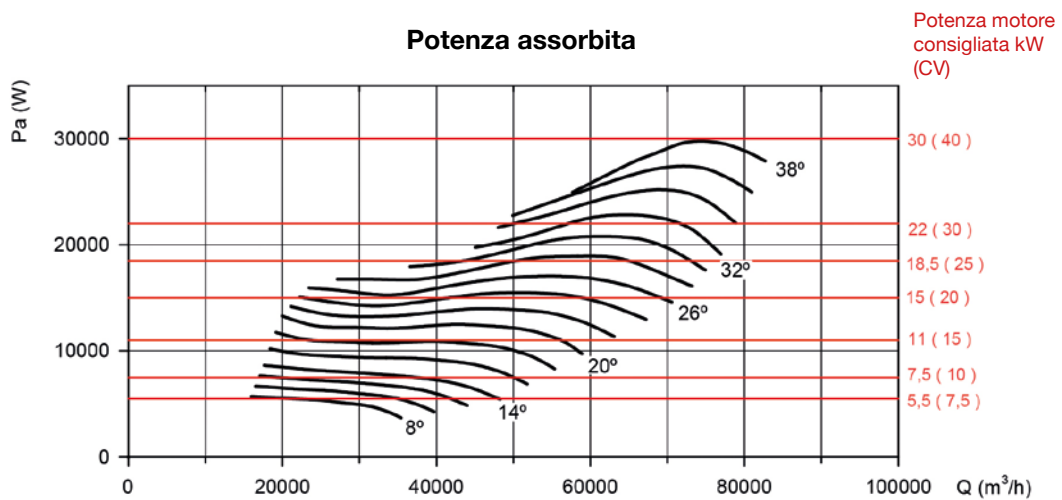

Curve caratteristiche

Q= Portata in m³/h, m³/s e cfm

Pe= Pressione statica in mmH₂O, Pa e inwg

Diametro girante in cm: 100

Numero di poli del motore: 6

Numero di pale: 6

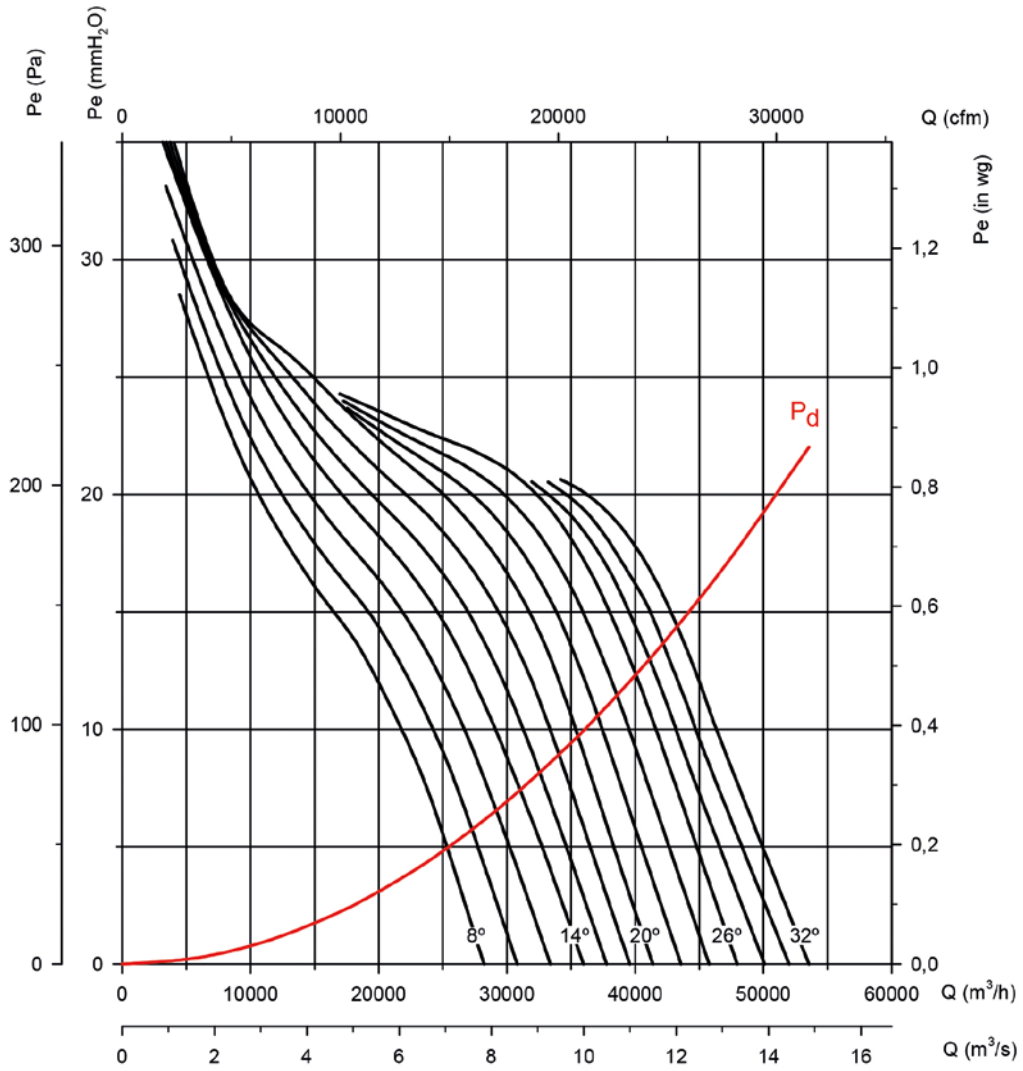

Potenza assorbita

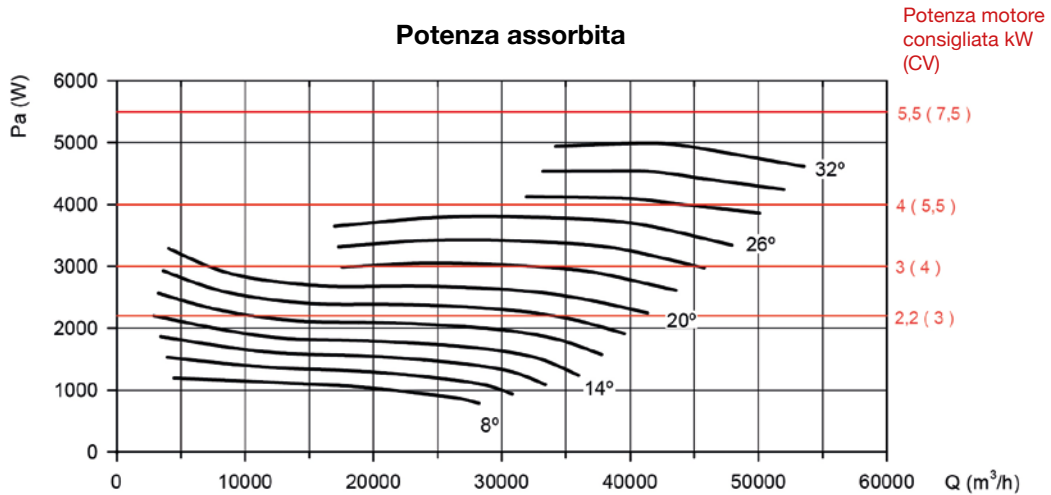

Curve caratteristiche

Q= Portata in m³/h, m³/s e cfm

Pe= Pressione statica in mmH₂O, Pa e inwg

Diametro girante in cm: 100

Numero di poli del motore: 6

Numero di pale: 9

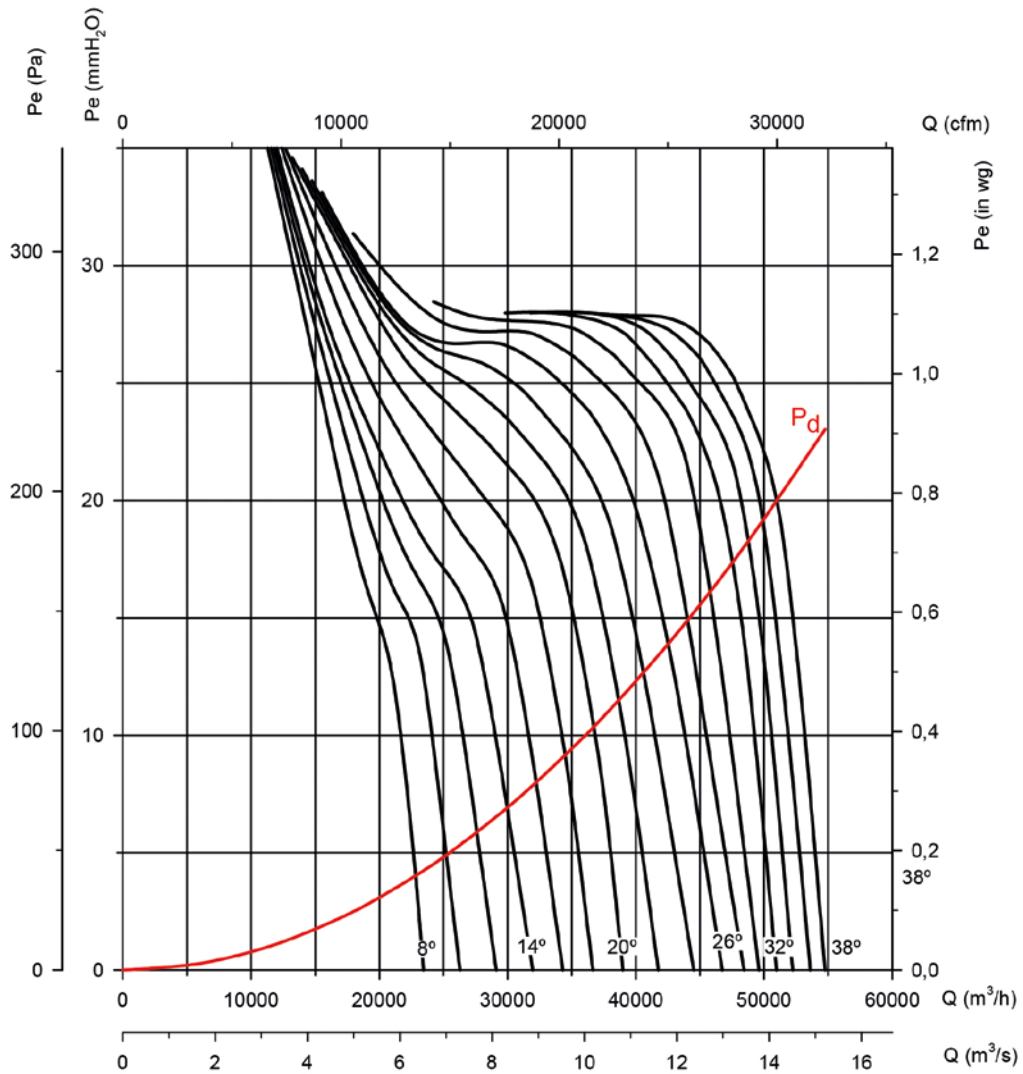

Potenza assorbita

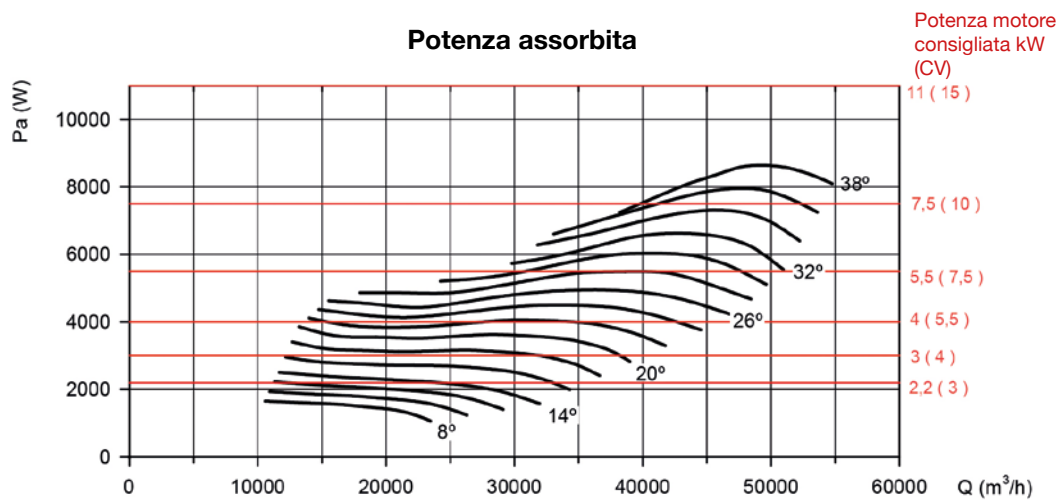

Curve caratteristiche

Q= Portata in m³/h, m³/s e cfm

Pe= Pressione statica in mmH₂O, Pa e inwg

Diametro girante in cm: 125

Numero di poli del motore: 4

Numero di pale: 6

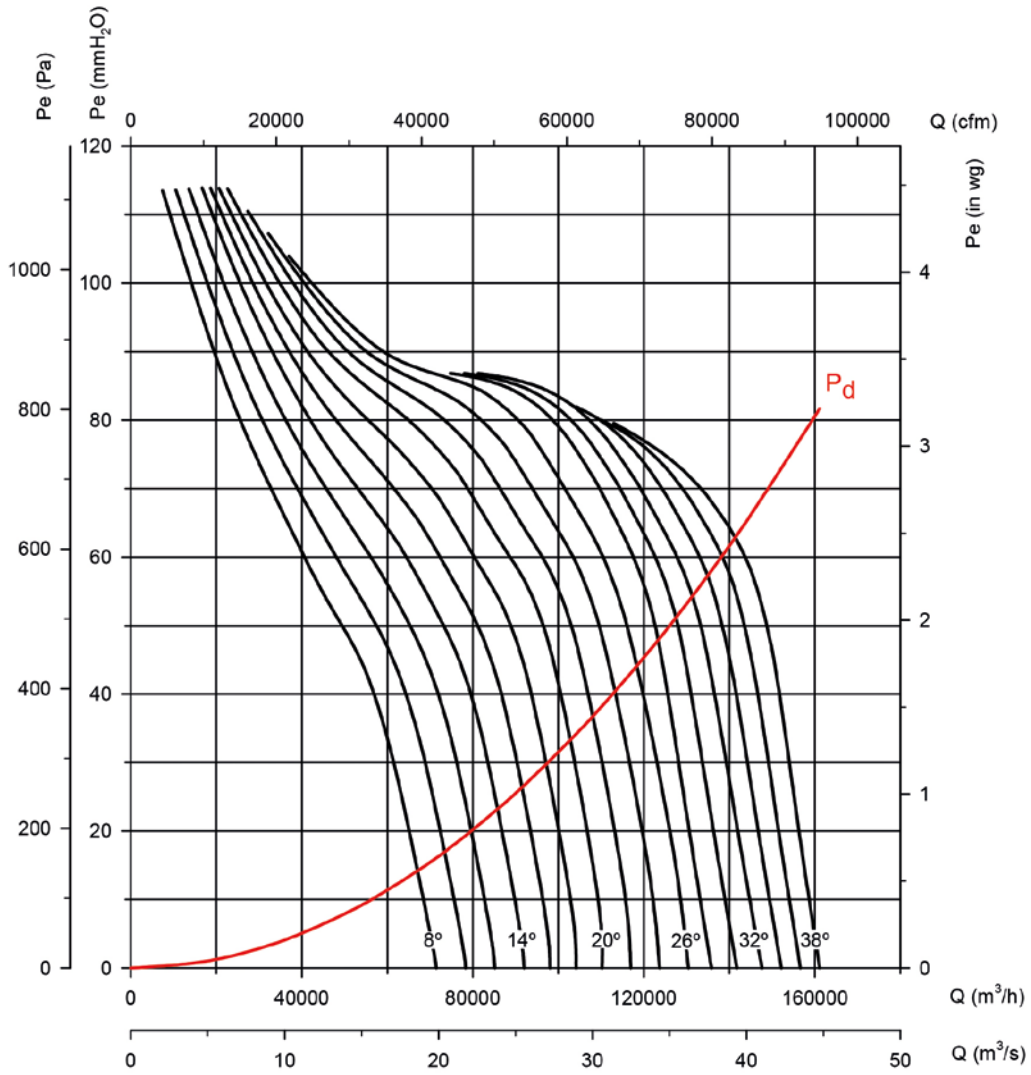

Potenza assorbita

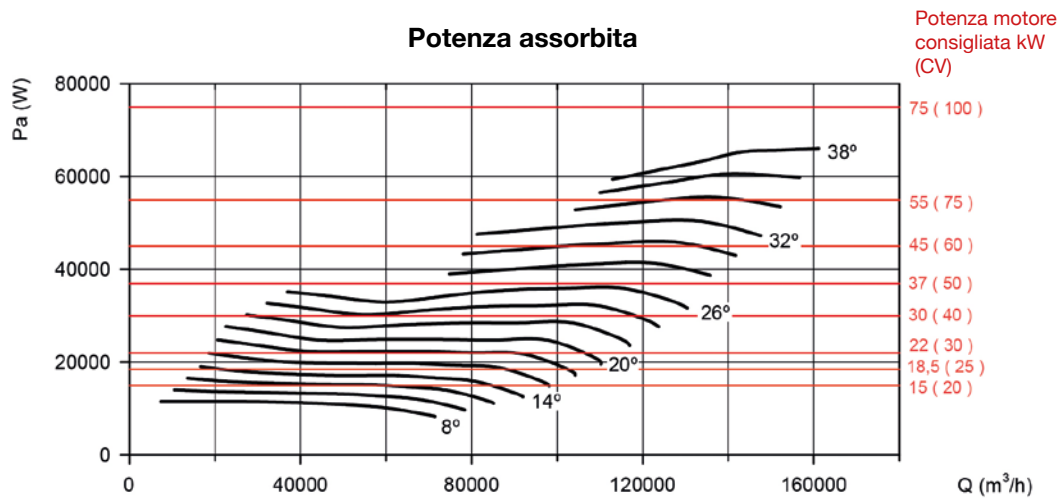

Curve caratteristiche

Q= Portata in m³/h, m³/s e cfm

Pe= Pressione statica in mmH₂O, Pa e inwg

Diametro girante in cm: 125

Numero di poli del motore: 4

Numero di pale: 9

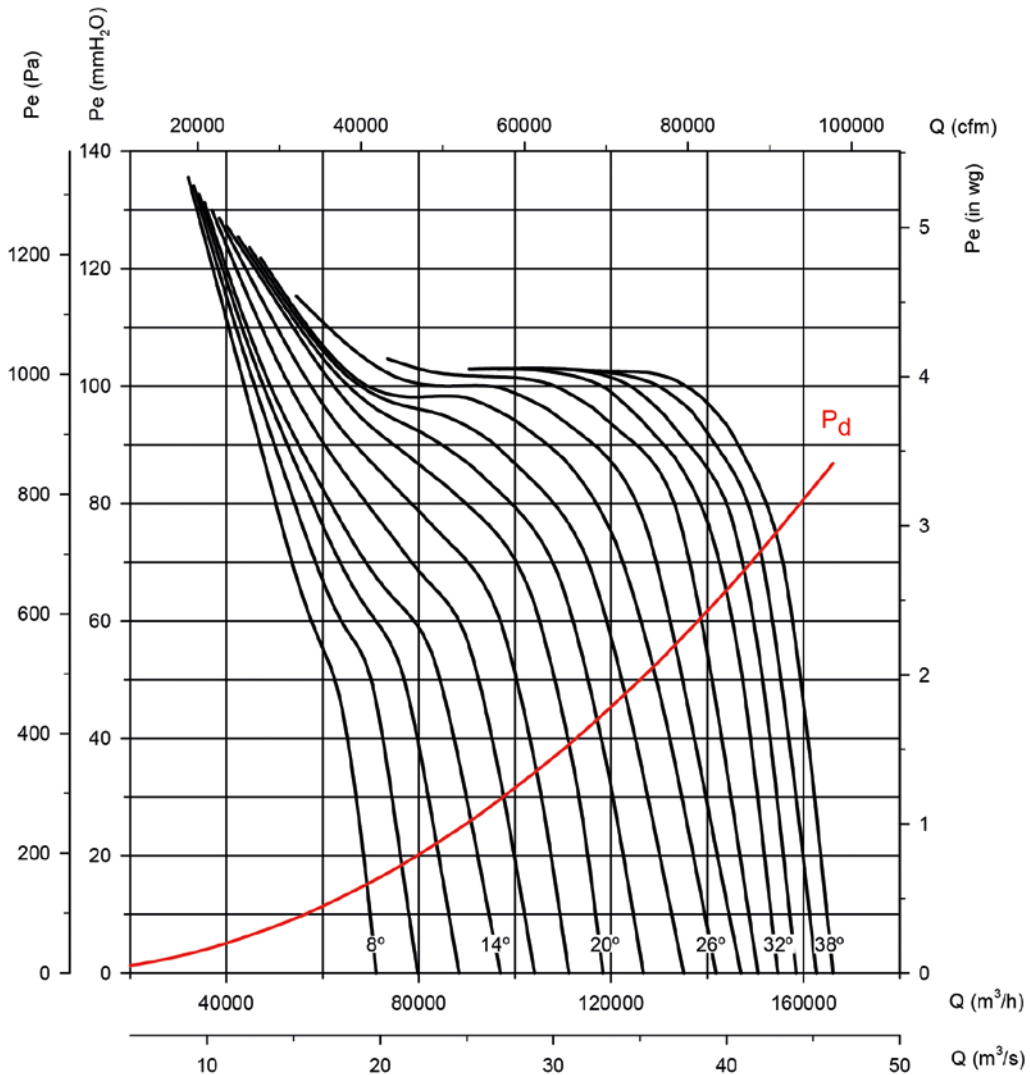

Potenza assorbita

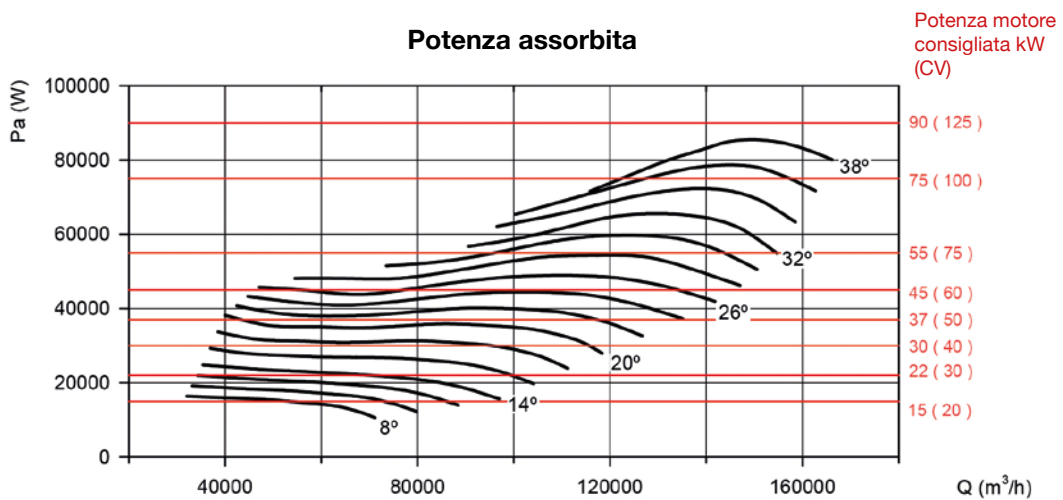

Curve caratteristiche

Q= Portata in m³/h, m³/s e cfm

Pe= Pressione statica in mmH₂O, Pa e inwg

Diametro girante in cm: 125

Numero di poli del motore: 4

Numero di pale: 12

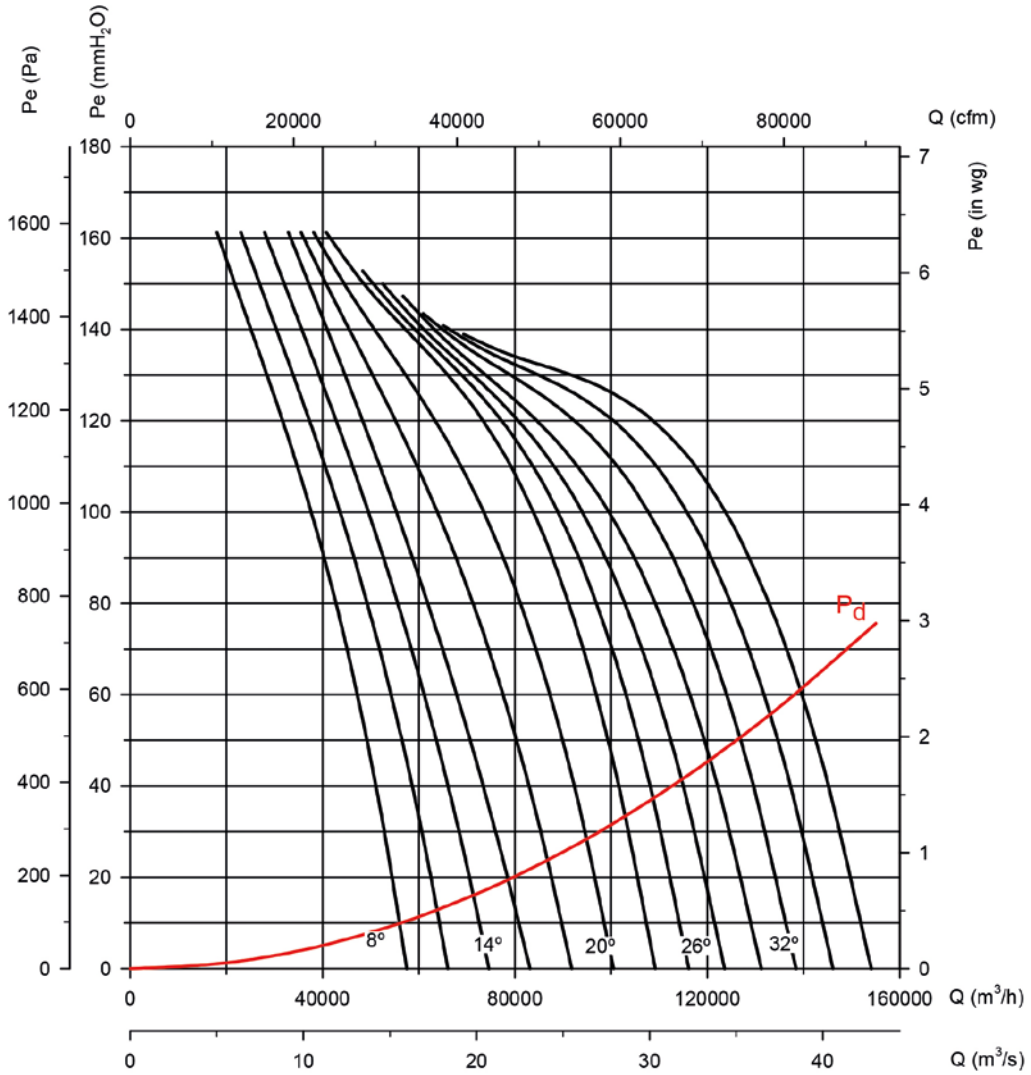

Potenza assorbita

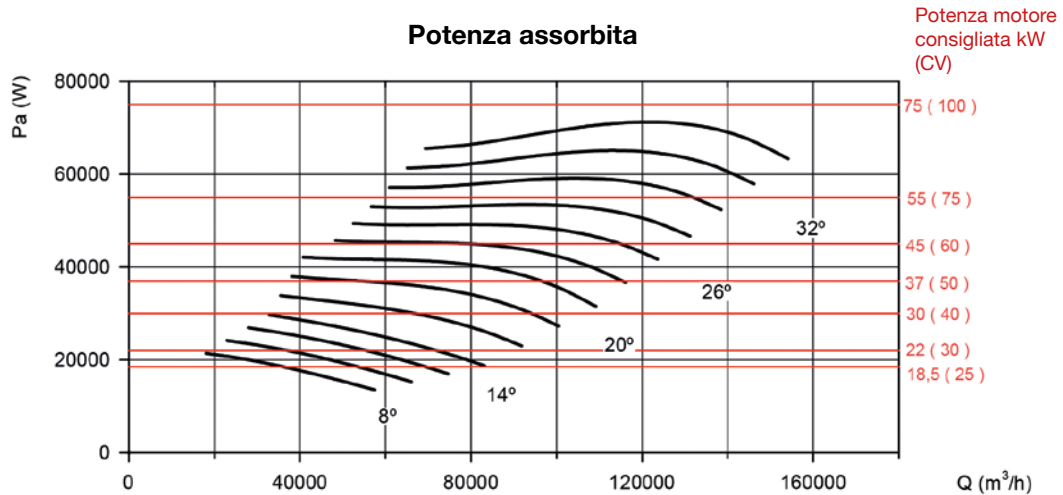

Curve caratteristiche

Q= Portata in m³/h, m³/s e cfm

Pe= Pressione statica in mmH₂O, Pa e inwg

Diametro girante in cm: 125

Numero di poli del motore: 6

Numero di pale: 6

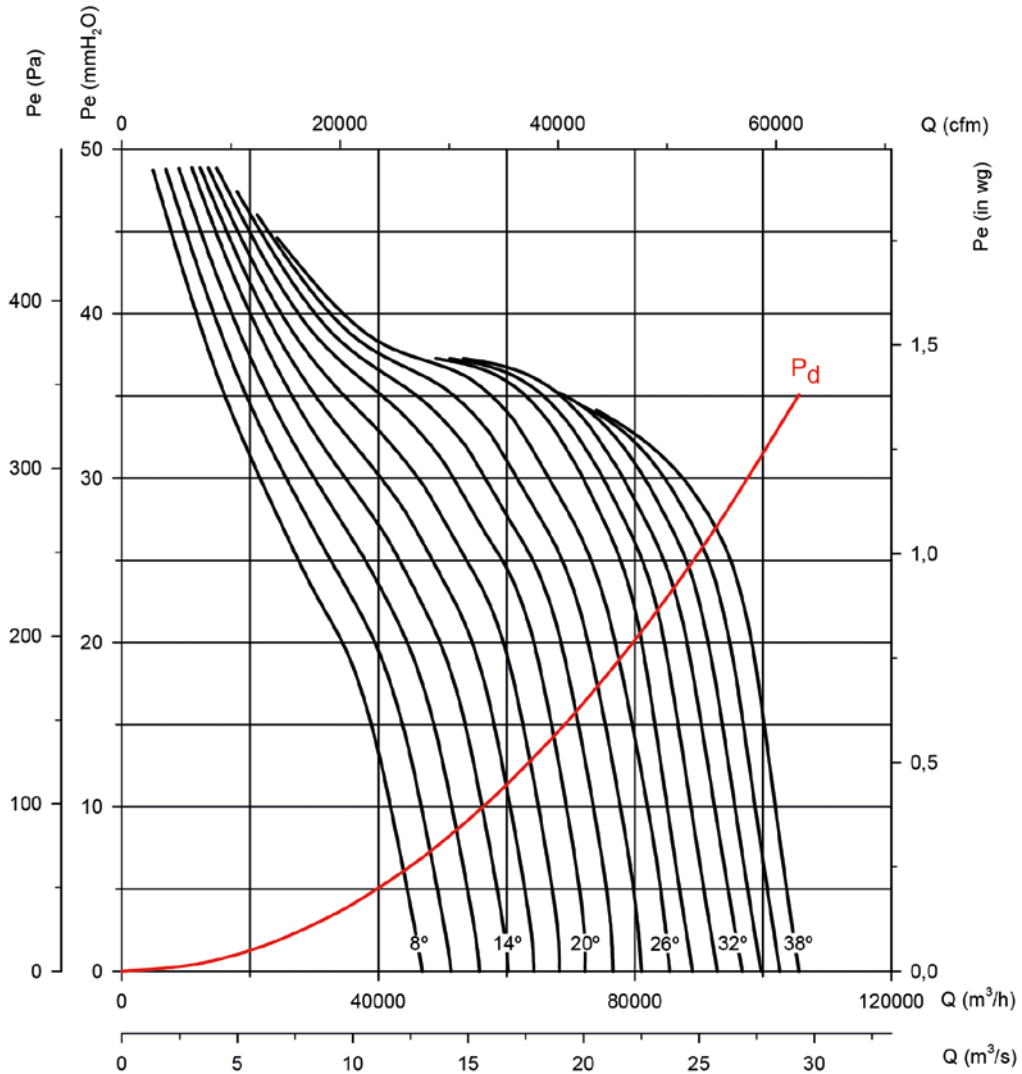

Potenza assorbita

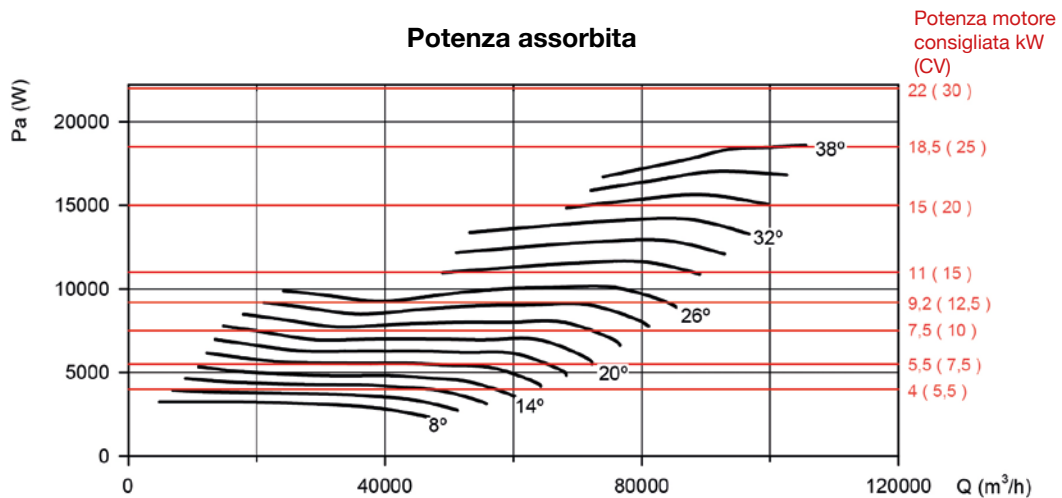

Curve caratteristiche

Q= Portata in m³/h, m³/s e cfm

Pe= Pressione statica in mmH₂O, Pa e inwg

Diametro girante in cm: 125

Numero di poli del motore: 6

Numero di pale: 9

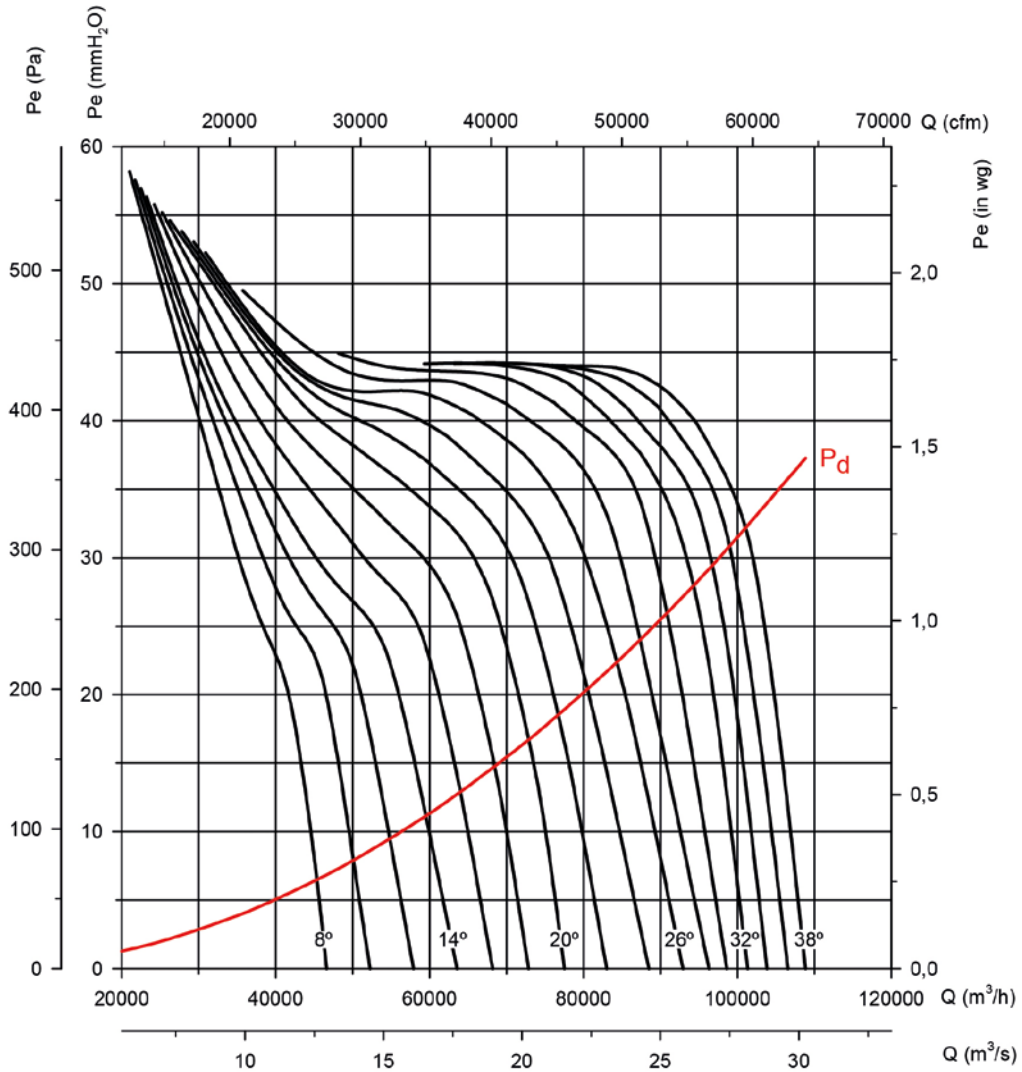

Potenza assorbita

Potenza motore consigliata kW (CV)

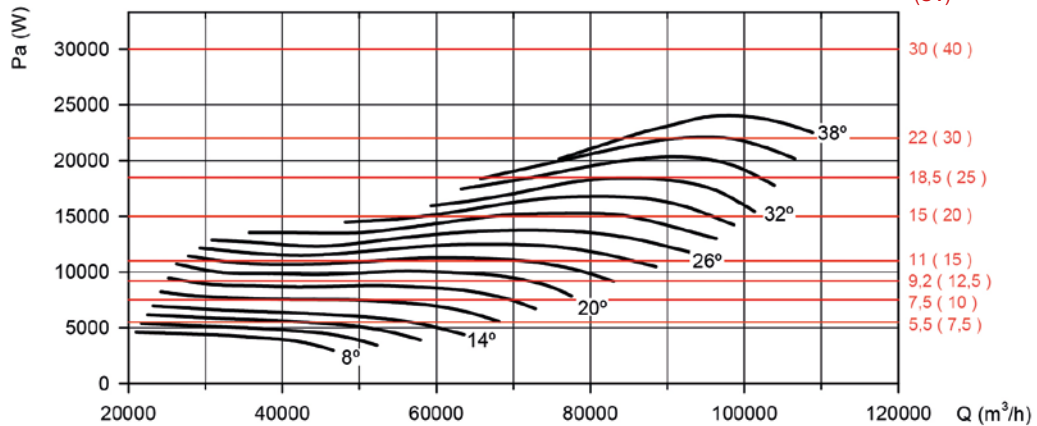

Curve caratteristiche

Q= Portata in m³/h, m³/s e cfm

Pe= Pressione statica in mmH₂O, Pa e inwg

Diametro girante in cm: 125

Numero di poli del motore: 6

Numero di pale: 12

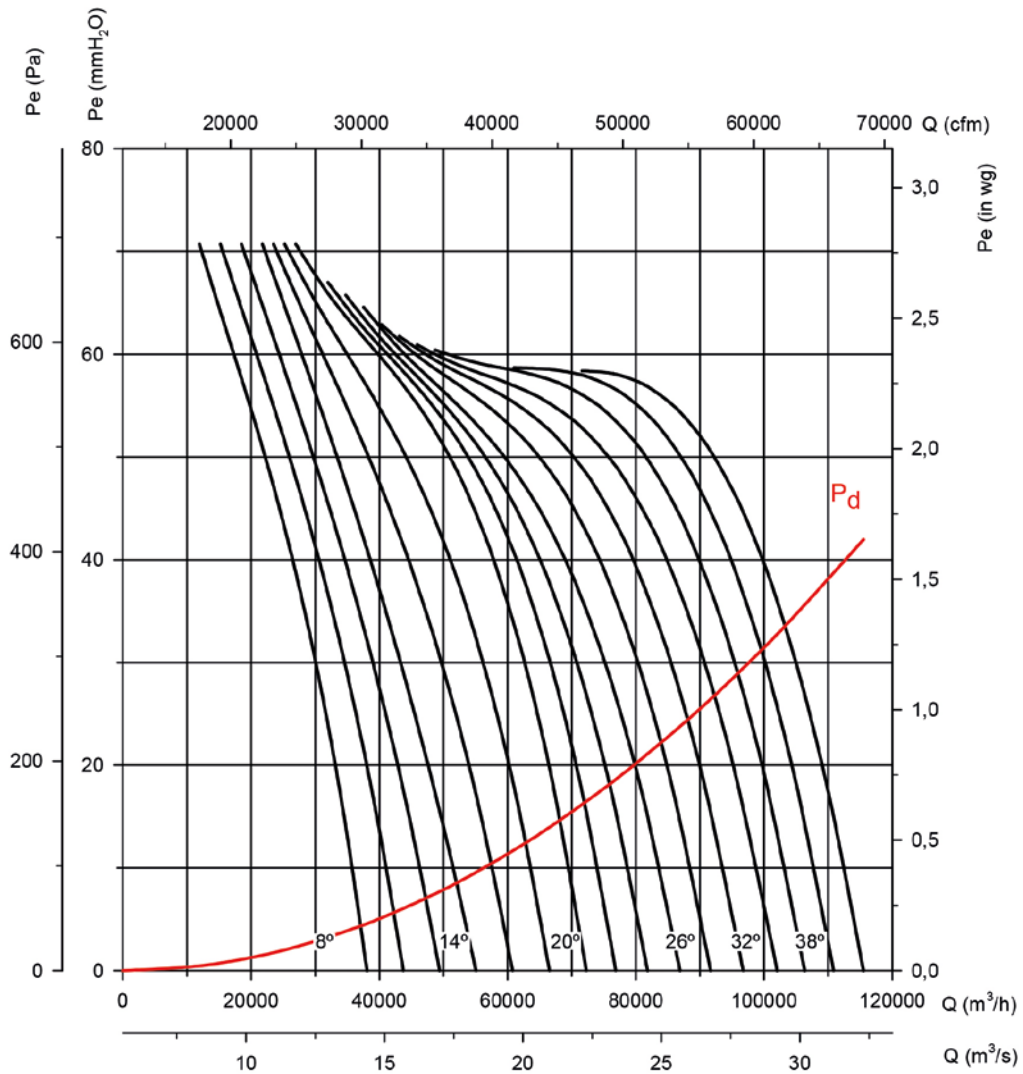

Potenza assorbita

