

NEOLINEO/EW



E.C. TECHNOLOGY
CON VSD INTEGRATO



Estrattori in linea per condotti, con corpo estraibile e dimensioni ridotte, provvisti di motore E.C. Technology.



CONTROLLO
Fornito come
accessorio opzionale

Ventilatore:

- Rivestimento in materiale plastico autoestingente V0.
- Morsettieria esterna, con posizione variabile.
- Installazione rapida e agevole.

Motore:

- Motori E.C. Technology con cuscinetti a sfere a lunga durata.
- Grado di protezione IP44.
- Due velocità selezionabili mediante commutatore.
- Ciascuna velocità è regolabile mediante il potenziometro contenuto nella morsettieria.

Modello 315 regolabile mediante segnale esterno 0-10 V.

- Monofase 220-240 V 50 Hz.
- Temperatura di esercizio:
Modelli 100, 125 e 150: -10 °C +60 °C.
Modelli 200, 250 e 315: -10 °C +50 °C.

Finitura:

- In materiale plastico, di colore bianco, autoestingente V0.

Codice di ordinazione

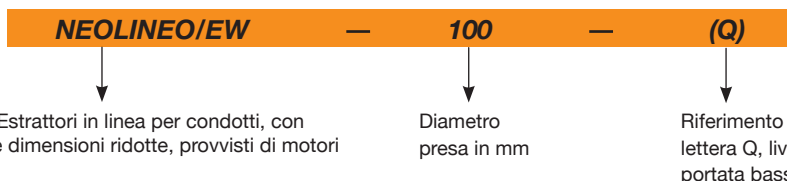

Caratteristiche tecniche

	Regolazione velocità	Velocità (giri/min) min/max	Intensità (A) min/max	Potenza (W) min/max	Portata massima (m3/h) min/max	Livello di pressione sonora Lp dB(A)* min/max	Peso circa (kg)	According ErP
NEOLINEO/EW-100-Q	Vel. min.	1420/2120	0,05/0,08	4,5/7	90/145	21/33	1,5	Non incluso
	Vel. nom.	2125/2850	0,07/0,12	7/12	155/210	29/40		
	Vel. max.	2560/3300	0,10/0,16	10/16,5	170/230	34/45		
NEOLINEO/EW-100	Vel. min.	1320/1650	0,06/0,09	5,5/8	140/185	25/31	1,9	Non incluso
	Vel. nom.	1620/2000	0,09/0,12	8/12	180/255	31/36		
	Vel. max.	1920/2330	0,11/0,17	11/17	220/270	36/41		
NEOLINEO/EW-125	Vel. min.	1285/1660	0,07/0,11	6,5/10,5	190/270	29/35	1,8	Non incluso
	Vel. nom.	1600/2040	0,10/0,17	10/17	250/365	35/40		
	Vel. max.	1870/2370	0,13/0,22	13,5/24	300/380	39/44		
NEOLINEO/EW-150	Vel. min.	1340/1895	0,10/0,20	10/22	325/440	35/44	2,2	Non incluso
	Vel. nom.	1630/2230	0,15/0,31	15/35	385/550	42/47		
	Vel. max.	1870/2560	0,20/0,44	22/52	465/620	46/53		
NEOLINEO/EW-160	Vel. min.	1300/1900	0,10/0,21	10/23	325/450	34/45	2,1	Non incluso
	Vel. nom.	1560/2290	0,15/0,33	15/38	385/570	39/48		
	Vel. max.	1830/2620	0,20/0,45	22/55	465/630	46/54		
NEOLINEO/EW-200	Vel. min.	1990/2330	0,21/0,32	22/34	620/760	39/44	2,5	Non incluso
	Vel. nom.	2400/2820	0,33/0,50	36/57	750/1000	45/46		
	Vel. max.	2750/3120	0,47/0,63	53/74	870/1080	45/48		
NEOLINEO/EW-250	Vel. min.	1720/2280	0,26/0,54	27/59	650/850	43/51	5,3	Non incluso
	Vel. nom.	2100/2750	0,42/0,83	45/95	800/1150	47/55		
	Vel. max.	2400/3010	0,59/1,06	65/124	920/1250	51/57		
NEOLINEO/EW-315		1800/2350	0,83/1,60	119/240	1400/1900	53/61	9,5	2015

*I livelli di pressione sonora irradiati sono ottenuti in campo libero a una distanza di 3 metri, con tubi rigidi in aspirazione e scarico.

Dimensioni in mm

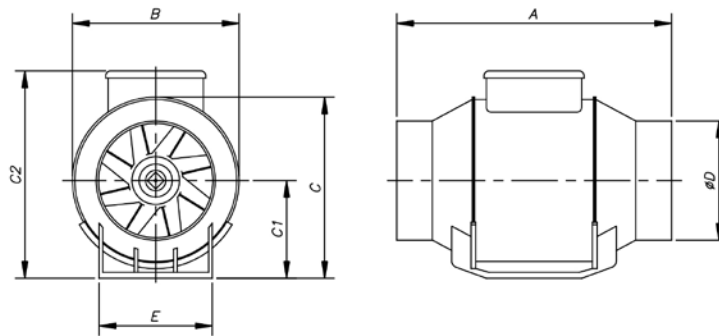

	A	B	C	C1	C2	ØD	E
NEOLINEO/EW-100-Q	231	156	205	82	152	96	95
NEOLINEO/EW-100	303	188,5	240	101,5	189	96	90
NEOLINEO/EW-125	258	188,5	240	101,5	189	122	90
NEOLINEO/EW-150	294	214,5	265	112,5	212	146	110
NEOLINEO/EW-160	272,5	214,5	265	112,5	212	156	110
NEOLINEO/EW-200	300	234,5	290	125,5	235	196	140
NEOLINEO/EW-250	385	300	350	152,5	292	247	176,5
NEOLINEO/EW-315	448	361,5	460	188,5	359	312	220,5



Erp. Curve caratteristiche e dati ErP

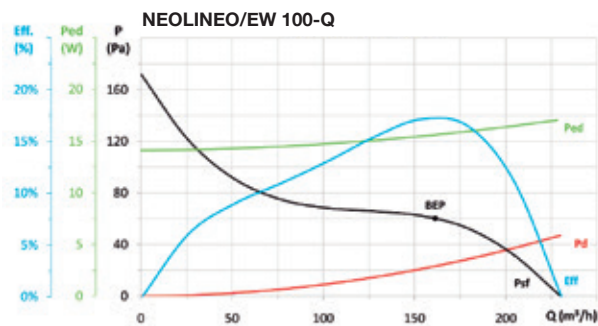

MC	EC	SR	Cc	η_{is} (%)*	N	[kW]	[m ³ /h]	[Pa]	[rpm]	VSD
A	S	-	-	-	-	0,016	161	60	3300	INTEGRATED

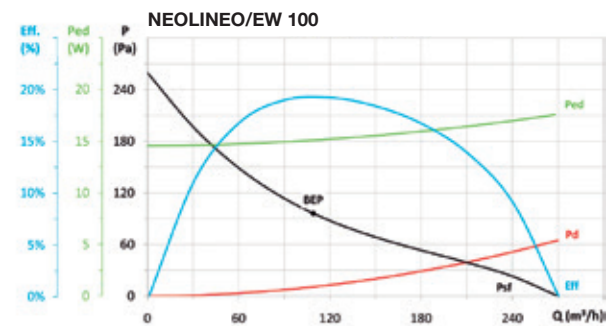

MC	EC	SR	Cc	η_{is} (%)*	N	[kW]	[m ³ /h]	[Pa]	[rpm]	VSD
A	S	-	-	-	-	0,015	109	96	2330	INTEGRATED

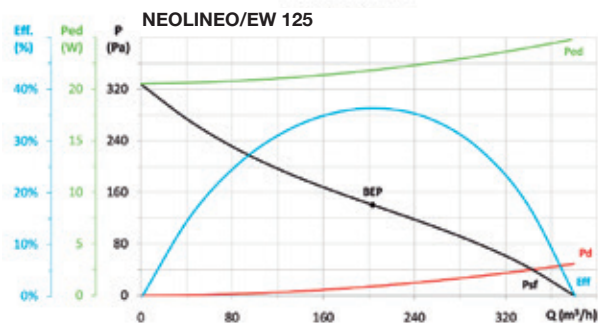

MC	EC	SR	Cc	η_{is} (%)*	N	[kW]	[m ³ /h]	[Pa]	[rpm]	VSD
A	S	-	-	-	-	0,022	203	140	2370	INTEGRATED

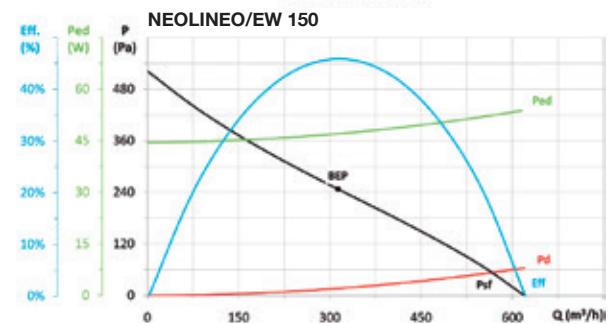

MC	EC	SR	Cc	η_{is} (%)*	N	[kW]	[m ³ /h]	[Pa]	[rpm]	VSD
A	S	-	-	-	-	0,047	313	247	2560	INTEGRATED



Erp. Curve caratteristiche e dati ErP

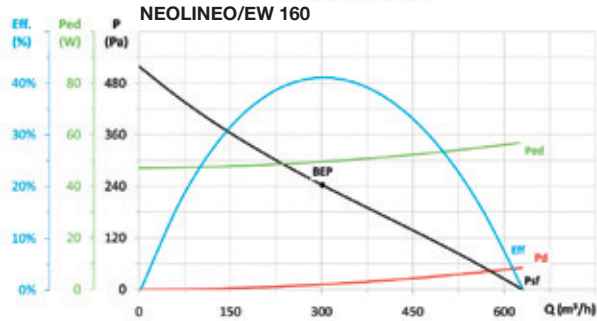

MC	EC	SR	Cc	η_e (%)*	N	[kW]	[m³/h]	[Pa]	[rpm]	VSD
A	S	-	-	-	-	0,049	301	242	2620	INTEGRATED

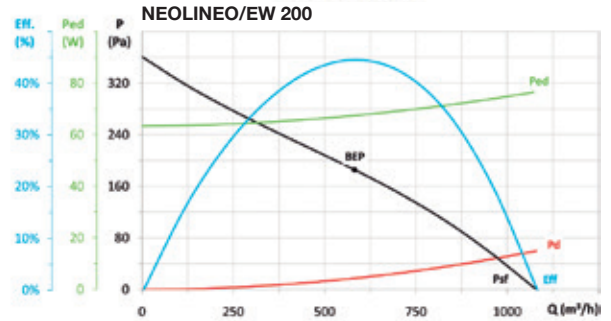

MC	EC	SR	Cc	η_e (%)*	N	[kW]	[m³/h]	[Pa]	[rpm]	VSD
A	S	-	-	-	-	0,067	582	185	3120	INTEGRATED

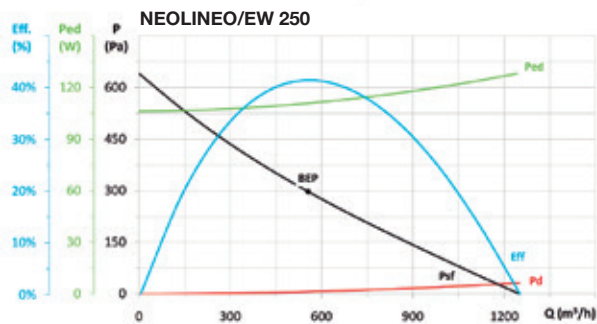

MC	EC	SR	Cc	η_e (%)*	N	[kW]	[m³/h]	[Pa]	[rpm]	VSD
A	S	-	-	-	-	0,111	556	297	3010	INTEGRATED

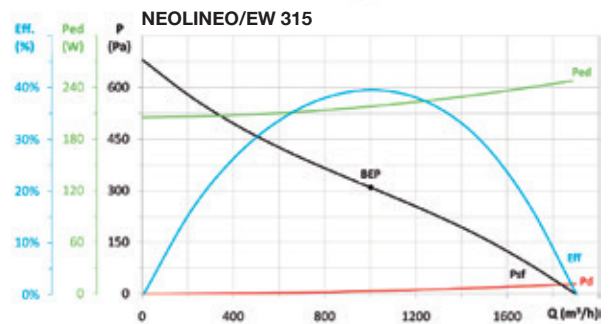

MC	EC	SR	Cc	η_e (%)*	N	[kW]	[m³/h]	[Pa]	[rpm]	VSD
A	S	1,00	1,13	44,8%	62,3	0,218	1002	309	2350	INTEGRATED

* η_e (%) = EFF. (%) x Cc