

CJTCR/R/EW



Unità di estrazione 400 °C/2h con girante con pale rovesce dotate di motore asincrono ad alto rendimento IE3 regolabile elettronicamente



VARIATORE VELOCITÀ
VSD: Variatore elettronico di velocità.
. VSD1/A-RFM
. VSD3/A-RFT

Fornitura su richiesta

CONTROLLO
Fornito come accessorio opzionale

ALIMENTAZIONE
VSD1/A-RFM:
220-240 V 50/60 Hz
VSD3/A-RFT:
380-415 V 50/60 Hz

Unità di estrazione 400 °C/2h con scatola dotata di isolamento acustico, per il funzionamento fuori da zone a rischio incendio, a semplice aspirazione e di elevata robustezza. Con di motore asincrono ad alto rendimento IE3 regolabile elettronicamente.

Ventilatore:

- Rivestimento in lamiera di acciaio.
- Girante con pale rovesce in lamiera di acciaio di elevata robustezza con vernice antitermica.
- Omologazione secondo la norma EN 12101-3.

Motore:

- Nuovi motori AC sincroni ad alto rendimento (IE3).
- Provvisti di cuscinetti a sfere a lunga durata. Grado di protezione IP55.
- Trifase 230/400 V 50 Hz (fino a 4 kW) e 400/690 V 50 Hz (potenze superiori a 4 kW).
- Temperatura massima dell'aria da movimentare: Servizio S1 -25 °C +250 °C in continuo. Servizio S2 300 °C/2h e 400 °C/2h.

Variatore elettronico di velocità:

- Velocità regolabile mediante segnale

0-10 V o controllo automatico PI integrato nel variatore.

- Variatore elettronico con numerose opzioni di configurazione, 2 ingressi analogici, 2 ingressi digitali, 1 uscita relè e 1 uscita a scelta tra analogica e digitale.
- Possibilità di connessione ai bus di campo MODBUS e CAN Open.
- Variatore elettronico di facile installazione all'esterno della zona di lavoro. Grazie alla guida DIN di cui è dotato, può essere installato in quadri comandi riducendo al minimo le connessioni necessarie.
- Fornito precablato con cavo schermato, in conformità alla direttiva EMC 2014/30/UE.
- Disponibili con ingresso monofase 220-240 V 50/60 Hz fino a 3 CV (tipo VSD1/A-RFM) o trifase 380-415 V 50/60 Hz (tipo VSD3/A-RFT). Grado di protezione standard IP20. Grado di protezione IP66 fino a 10 CV su richiesta.
- Temperatura di esercizio (VSD): -25 °C +50 °C.

Finitura:

- Lamiera di acciaio galvanizzato anticorrosione.

Codice ordine ventilatore

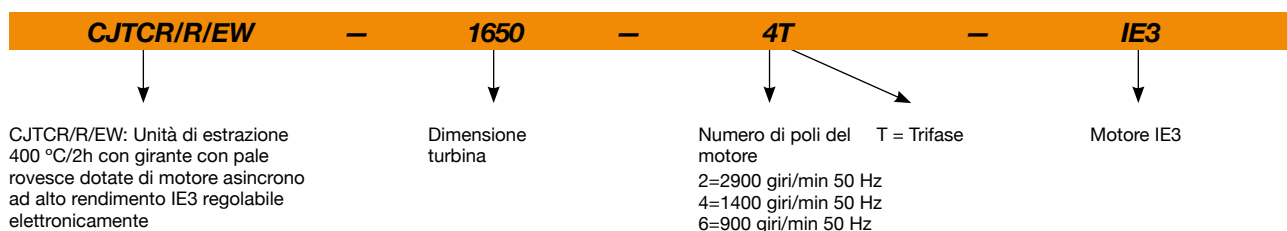

Codice ordine con fornitura del variatore elettronico (VSD) compreso

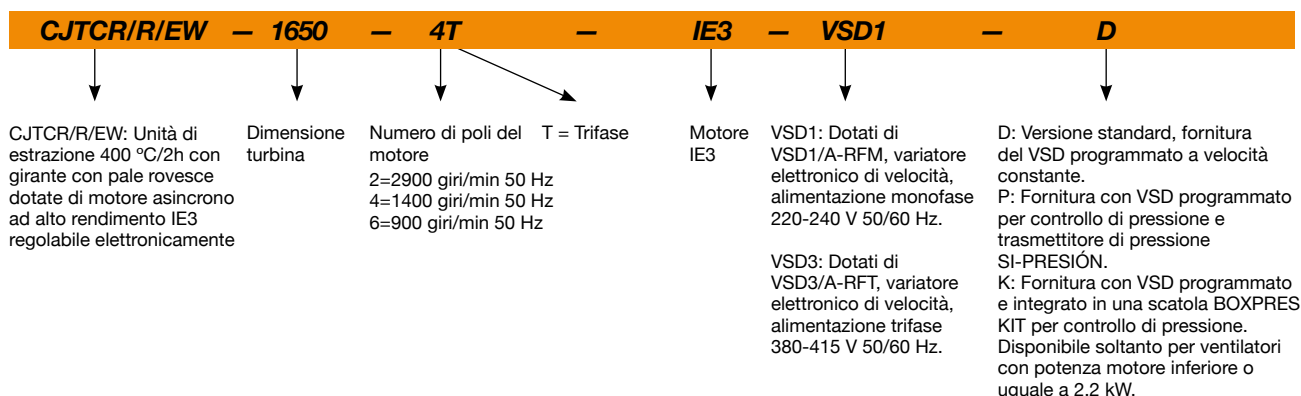

Caratteristiche tecniche

Modello	Velocità min/max (giri/min)	VSD monofase 230 V 50/60 Hz		VSD trifase 400 V 50/60 Hz		Intensità massima motore 50 Hz (A)			Potenza installata (kW)	Portata min/max (m³/h)	Livello di pressione sonora min/max dB (A)	Peso circa (Kg)
		Intensità massima di ingresso (A)	Modello VSD	Intensità massima di ingresso (A)	Modello VSD	230V	400V	690V				
CJTCR/R/EW-1240-2T-IE3	1160/2900	-	-	9,44	VSD3/A-RFT-5.5	13,00	7,50	-	4,00	4440 / 11110	57/77	147
CJTCR/R/EW-1240-4T-IE3	570/1420	8,32	VSD1/A-RFM-1	2,31	VSD3/A-RFT-1	2,82	1,62	-	0,75	2330 / 5830	42/62	125
CJTCR/R/EW-1445-2T-IE3	1170/2935	-	-	17,45	VSD3/A-RFT-10	-	13,90	8,06	7,50	6620 / 16560	60/80	210
CJTCR/R/EW-1445-4T-IE3	580/1455	11,87	VSD1/A-RFM-2	3,30	VSD3/A-RFT-2	4,07	2,34	-	1,10	3240 / 8100	45/65	177
CJTCR/R/EW-1650-4T-IE3	580/1440	15,78	VSD1/A-RFM-2	4,38	VSD3/A-RFT-2	5,41	3,11	-	1,50	4240 / 10600	46/66	189
CJTCR/R/EW-1650-6T-IE3	380/940	8,69	VSD1/A-RFM-1	2,41	VSD3/A-RFT-1	3,36	1,93	-	0,75	2980 / 7450	37/57	186
CJTCR/R/EW-1856-4T-IE3	580/1440	-	-	7,20	VSD3/A-RFT-5.5	10,70	6,15	-	3,00	6100 / 15240	53/73	273
CJTCR/R/EW-1856-6T-IE3	380/945	12,43	VSD1/A-RFM-2	3,45	VSD3/A-RFT-2	4,68	2,69	-	1,10	4020 / 10040	45/65	266
CJTCR/R/EW-2063-4T-IE3	590/1465	-	-	12,81	VSD3/A-RFT-7.5	-	10,30	5,97	5,50	9800 / 24490	55/75	380
CJTCR/R/EW-2063-6T-IE3	380/950	16,64	VSD1/A-RFM-2	4,62	VSD3/A-RFT-2	6,43	3,70	-	1,50	6460 / 16140	45/65	364
CJTCR/R/EW-2271-4T-IE3	590/1470	-	-	25,10	VSD3/A-RFT-15	-	21,40	12,40	11,00	13900 / 34760	62/82	508
CJTCR/R/EW-2271-6T-IE3	390/970	-	-	7,39	VSD3/A-RFT-5.5	12,00	6,91	-	3,00	9200 / 23000	52/72	473



Erp. (Energy Related Products)

Informazioni sulla direttiva 2009/125/CE scaricabili dal sito web di SODECA o da QuickFan Selector.

Caratteristiche acustiche

I valori indicati vengono determinati tramite le misurazioni del livello di pressione e di potenza sonora in dB(A) ottenute in campo libero a una distanza equivalente a due volte l'apertura del ventilatore più il diametro della turbina, con un minimo di 1,5 metri.

Spettro di potenza sonora Lw(A) in dB(A) per banda di frequenza in Hz

	63	125	250	500	1000	2000	4000	8000		63	125	250	500	1000	2000	4000	8000
CJTCR/R/EW-1240-2T	63	78	76	88	85	89	91	78	CJTCR/R/EW-1856-4T	64	73	86	82	85	86	80	66
CJTCR/R/EW-1240-4T	51	65	71	74	74	75	65	54	CJTCR/R/EW-1856-6T	56	64	76	78	75	76	66	55
CJTCR/R/EW-1445-2T	68	80	78	90	88	92	94	84	CJTCR/R/EW-2063-4T	75	80	86	88	86	83	76	68
CJTCR/R/EW-1445-4T	54	67	73	78	75	78	73	59	CJTCR/R/EW-2063-6T	64	65	77	77	76	78	68	58
CJTCR/R/EW-1650-4T	58	68	76	78	77	79	70	60	CJTCR/R/EW-2271-4T	79	80	89	92	94	95	91	78
CJTCR/R/EW-1650-6T	48	60	67	72	68	64	57	49	CJTCR/R/EW-2271-6T	68	68	82	81	85	85	74	63

Orientamenti

Fornitura standard LG 270

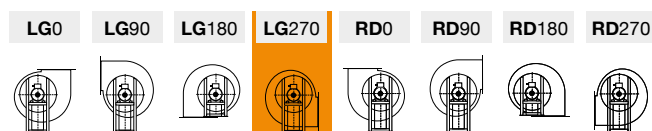

Dimensioni in mm

Fornitura standard: LG 270

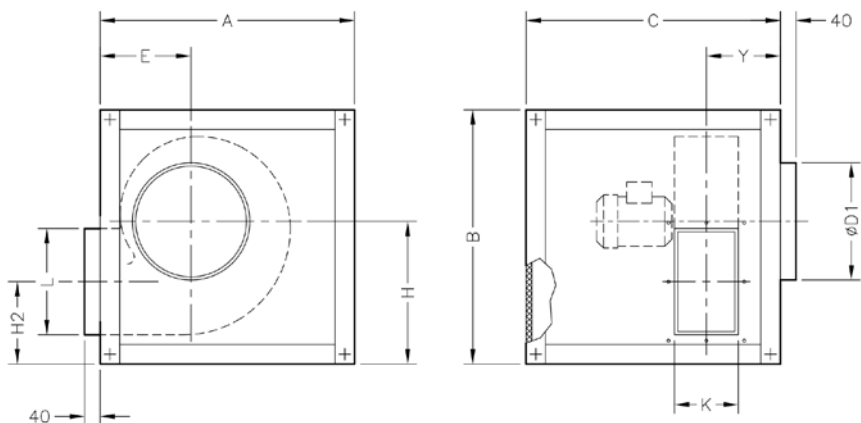

	A	B	C	ØD1	E	H	H2	K	L	Y
CJTCR/R/EW-1240	970	970	970	400	312	549	308	315	400	307,5
CJTCR/R/EW-1445	1070	1070	1070	450	357	610	339	355	450	333,5
CJTCR/R/EW-1650	1160	1160	1160	500	382	660	365	400	500	355
CJTCR/R/EW-1856	1260	1260	1050	560	422	727	399	450	560	360
CJTCR/R/EW-2063	1400	1400	1200	630	472	810	444	500	630	395
CJTCR/R/EW-2271	1555	1555	1355	710	532	906	489	560	715	430

Fornitura su richiesta: LG 90

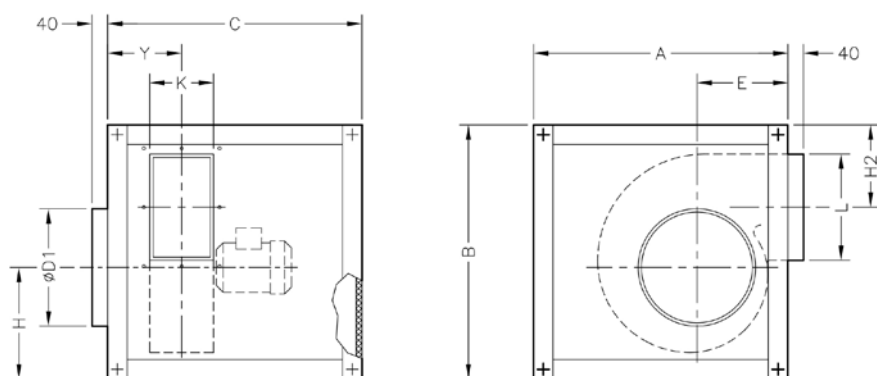

	A	B	C	ØD1	E	H	H2	K	L	Y
CJTCR/R/EW-1240	970	970	970	400	312	379	350	315	400	307,5
CJTCR/R/EW-1445	1070	1070	1070	450	357	408	391	355	450	333,5
CJTCR/R/EW-1650	1160	1160	1160	500	382	447	419	400	500	355
CJTCR/R/EW-1856	1260	1260	1050	560	422	495	438	450	560	360
CJTCR/R/EW-2063	1400	1400	1200	630	472	546	488	500	630	395
CJTCR/R/EW-2271	1555	1555	1355	710	532	607	532	560	715	430

Dimensioni in mm

Fornitura su richiesta: LG 0

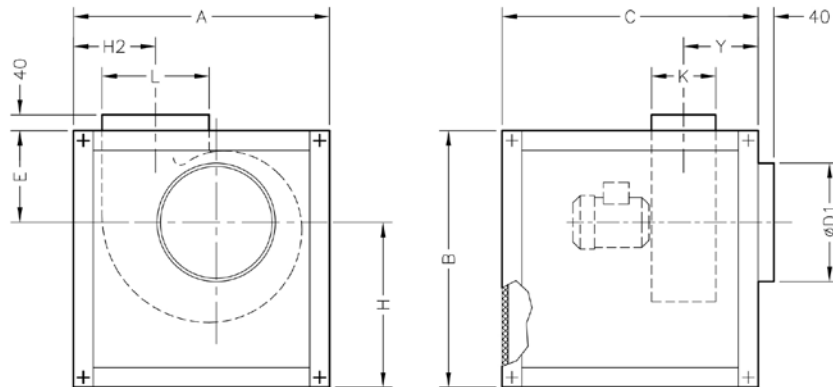

	A	B	C	ØD1	E	H	H2	K	L	Y
CJTCR/R/EW-1240	970	970	970	400	533	437	322	315	400	307,5
CJTCR/R/EW-1445	1070	1070	1070	450	586	484	367	355	450	333,5
CJTCR/R/EW-1650	1160	1160	1160	500	634,5	525,5	391,5	400	500	355
CJTCR/R/EW-1856	1260	1260	1050	560	681,5	578,5	442,5	450	560	360
CJTCR/R/EW-2063	1400	1400	1200	630	759	641	482	500	630	395
CJTCR/R/EW-2271	1555	1555	1355	710	838	717	518,5	560	715	430

Bocchetta di mandata

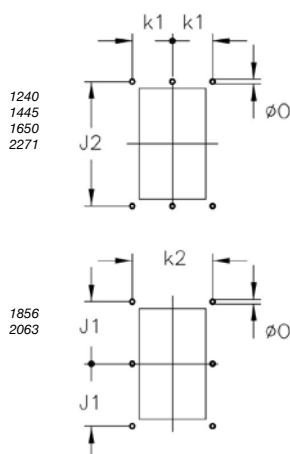

	k1	k2	J1	J2	ØO
CJTCR/R/EW-1240	177,5	-	-	440	11
CJTCR/R/EW-1445	202,5	-	-	498	11
CJTCR/R/EW-1650	225	-	-	550	13
CJTCR/R/EW-1856	-	500	305	-	13
CJTCR/R/EW-2063	-	560	345	-	13
CJTCR/R/EW-2271	312,5	-	-	775	13

Curve caratteristica

Q= Portata in m³/h, m³/s e cfm

Pe= Pressione statica in mmH₂O, Pa e inwg

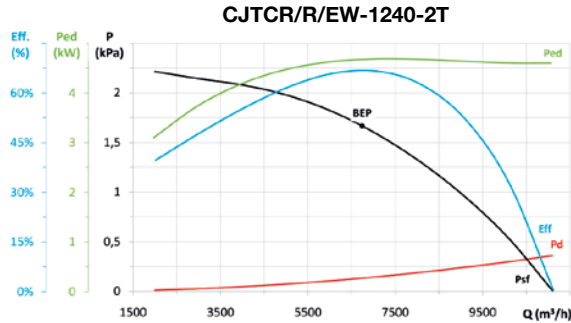

MC	EC	SR	Cc	η_e (%)*	N	[kW]	[m ³ /h]	[Pa]	[rpm]	VSD
A	S	1,02	1,04	69,6%	73,1	4,675	6744	1667,2	2901	NECESSARY

* η_e (%) = Eff. (%) x Cc

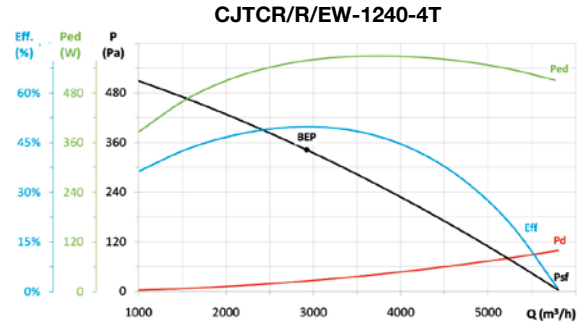

MC	EC	SR	Cc	η_e (%)*	N	[kW]	[m ³ /h]	[Pa]	[rpm]	VSD
A	S	1,00	1,11	55,1%	68,2	0,558	2924	342,3	1453	NECESSARY

* η_e (%) = Eff. (%) x Cc

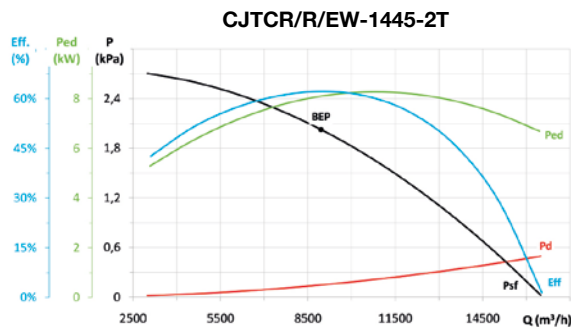

MC	EC	SR	Cc	η_e (%)*	N	[kW]	[m ³ /h]	[Pa]	[rpm]	VSD
A	S	1,02	1,04	64,6%	65,6	8,103	8951	2025,7	2939	NECESSARY

* η_e (%) = Eff. (%) x Cc

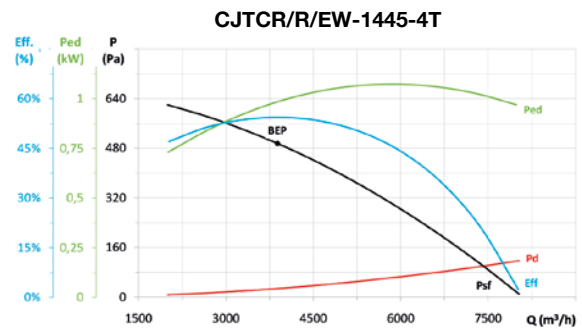

MC	EC	SR	Cc	η_e (%)*	N	[kW]	[m ³ /h]	[Pa]	[rpm]	VSD
A	S	1,01	1,09	59,1%	69,7	0,983	3883	495,3	1468	NECESSARY

* η_e (%) = Eff. (%) x Cc

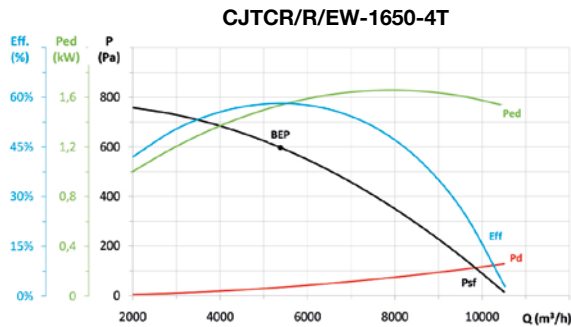

MC	EC	SR	Cc	η_e (%)*	N	[kW]	[m ³ /h]	[Pa]	[rpm]	VSD
A	S	1,01	1,08	62,5%	71,1	1,535	5378	597,4	1449	NECESSARY

* η_e (%) = Eff. (%) x Cc

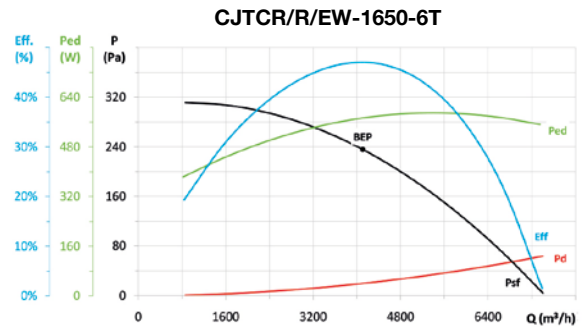

MC	EC	SR	Cc	η_e (%)*	N	[kW]	[m ³ /h]	[Pa]	[rpm]	VSD
A	S	1,00	1,10	52,0%	65,0	0,572	4109	235,7	966	NECESSARY

* η_e (%) = Eff. (%) x Cc

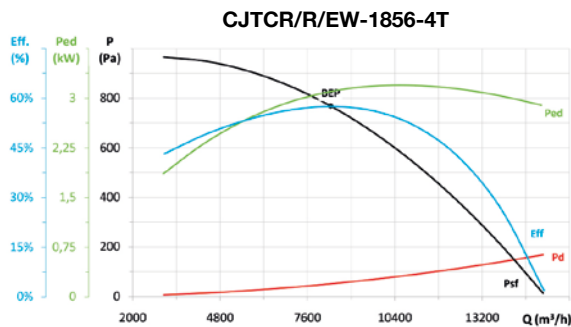

MC	EC	SR	Cc	η_e (%)*	N	[kW]	[m ³ /h]	[Pa]	[rpm]	VSD
A	S	1,01	1,05	60,6%	65,9	3,096	8342	768,0	1448	NECESSARY

* η_e (%) = Eff. (%) x Cc

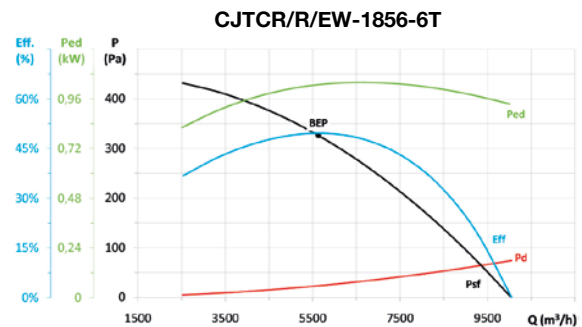

MC	EC	SR	Cc	η_e (%)*	N	[kW]	[m ³ /h]	[Pa]	[rpm]	VSD
A	S	1,00	1,09	53,9%	64,3	1,028	5632	326,1	960	NECESSARY

* η_e (%) = Eff. (%) x Cc

Curve caratteristiche

Q= Portata in m³/h, m³/s e cfm

Pe= Pressione statica in mmH₂O, Pa e inwg

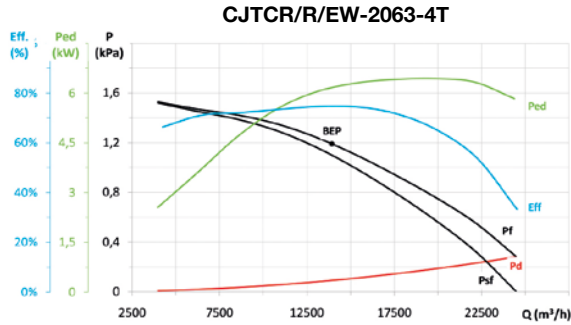

MC	EC	SR	Cc	η_e (%)*	N	[kW]	[m ³ /h]	[Pa]	[rpm]	VSD
B	T	1,01	1,04	77,8%	80,0	6,161	13932	1190,7	1466	NECESSARY

* η_e (%) = Eff. (%) x Cc

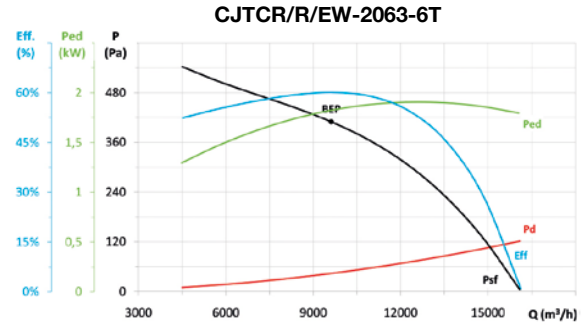

MC	EC	SR	Cc	η_e (%)*	N	[kW]	[m ³ /h]	[Pa]	[rpm]	VSD
A	S	1,00	1,07	64,3%	72,1	1,822	9620	409,7	952	NECESSARY

* η_e (%) = Eff. (%) x Cc

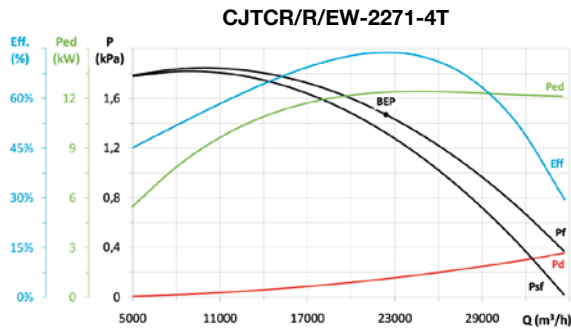

MC	EC	SR	Cc	η_e (%)*	N	[kW]	[m ³ /h]	[Pa]	[rpm]	VSD
B	T	1,01	1,04	76,8%	76,7	12,369	22380	1469,6	1470	NECESSARY

* η_e (%) = Eff. (%) x Cc

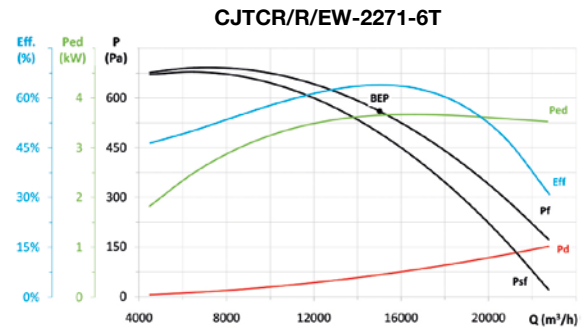

MC	EC	SR	Cc	η_e (%)*	N	[kW]	[m ³ /h]	[Pa]	[rpm]	VSD
B	T	1,01	1,05	67,1%	71,7	3,654	15016	560,2	970	NECESSARY

* η_e (%) = Eff. (%) x Cc

Accessori

