

CRF/EW

Centrifugal rooftop fans with low noise level, equipped with EC Technology external rotor motor



Roof-mounted centrifugal extractor fans with low noise level and external rotor motor, fitted with a EC Technology motor and a built-in speed regulating power meter.

- Single-phase 230 V 50/60 Hz and three-phase 400 V 50/60 Hz.
- Working temperature: -25 °C +50 °C.

Finish:

- Anti-corrosive in galvanized steel sheet.

Fan:

- Galvanized steel sheet construction.
- Backward curved impeller made of plastic material.
- Bird protection grid.
- Folding body for ease of inspection and maintenance.

Motor:

- New EC motors with external rotor, high efficiency and adjustable by means of a 0-10 V signal. IP54 protection.



Order code

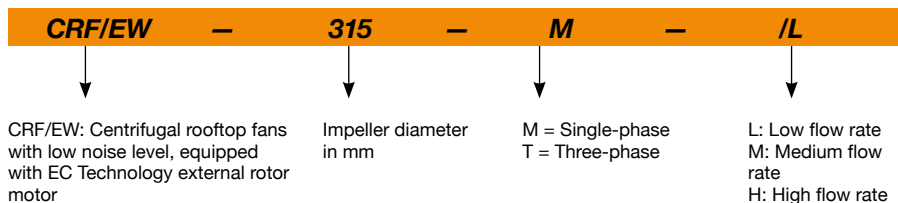

Technical characteristics

Model	Max. speed (r/min)	Maximum admissible current (A)		Max. electric power (kW)	Maximum flow rate (m ³ /h)	NPS at maximum speed dB (A)*		Approx. weight (Kg)	According ErP
		230V	400V			Inlet	Exhaust		
CRF/EW-190-M	3570	1.01		0.127	718	42	45	10	2018
CRF/EW-250-M	2850	1.35		0.180	1553	44	47	12	2018
CRF/EW-315-M/L	1920	1.35		0.175	2223	35	38	16	2018
CRF/EW-315-M/H	2377	2.00		0.450	2597	49	52	18	2018
CRF/EW-400-M/M	1550	2.00		0.460	3811	45	48	27	2018
CRF/EW-400-M/H	1700	4.70		0.750	5202	49	52	28	2018
CRF/EW-400-T	2000		1.68	0.950	5573	51	58	29	2018
CRF/EW-500-M	1200	4.80		0.720	6831	43	49	48	2018
CRF/EW-500-T/L	1250		2.00	1.150	7401	48	54	50	2018

* The noise level values are pressures in dB(A) measured at a distance of 6 metres and at 2/3 of the maximum flow rate (2/3 Qmax).



Erp. (Energy Related Products)

Information on Directive 2009/125/EC can be downloaded from the SODECA website or the QuickFan selector programme.

Acoustic characteristics

Sound power spectrum $L_w(A)$ in dB(A) per Hz frequency band

Values measured at inlet with 2/3 maximum flow rate (2/3 Q_{max}).

	63	125	250	500	1000	2000	4000	8000
190-M	28	45	51	58	60	61	57	52
250-M	34	49	55	60	62	61	59	50
315-M/L	29	51	48	53	53	51	47	40
315-M/H	46	61	63	66	65	66	61	55
400-M/M	46	60	57	63	61	59	54	57
400-M/H	39	63	62	68	65	63	58	60
400-T	40	53	65	71	68	68	63	63
500-M	41	55	56	60	62	61	57	50
500-T/L	45	57	60	65	65	65	62	56

Values measured at exhaust with 2/3 maximum flow rate (2/3 Q_{max}).

	63	125	250	500	1000	2000	4000	8000
190-M	31	48	54	61	63	64	60	55
250-M	37	52	58	63	65	64	62	53
315-M/L	32	54	51	56	56	54	50	43
315-M/H	49	64	66	69	68	69	64	58
400-M/M	49	63	60	66	64	62	57	60
400-M/H	42	66	65	71	68	66	61	63
400-T	45	56	68	73	78	76	70	66
500-M	43	56	59	67	69	65	59	53
500-T/L	46	59	63	71	75	69	65	59

Dimensions mm

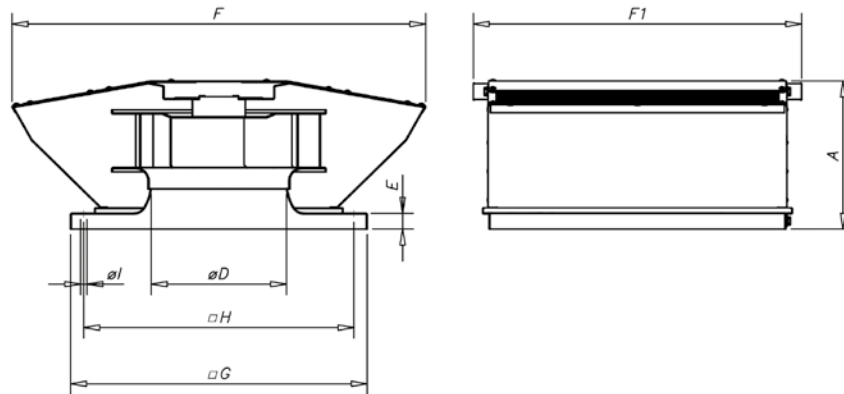

	A	ØD*	E	F	F1	G	H	øl
CRF/EW-190	185	124	30	477	420	355	305	12
CRF/EW-250	190	165	30	518	465	400	350	12
CRF/EW-315	277	204	30	701	515	450	400	12
CRF/EW-400	365	257	30	850	622	560	510	12
CRF/EW-500	426	321	30	1137	775	710	660	12

* Recommended nominal tube diameter

Accessories



INT



RM



PA

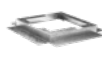

MS



PT



SI-CO2 IND



SI-TEMP IND



SI-TEMP+HUMEDAD



SI-HUMEDAD



SI-MF



SI-PRESIÓN

Characteristic curves

Q= Flow rate in m³/h, m³/s and cfm

Pe= Static pressure in mm H₂O, Pa and inwg

CRF/EW-190-M

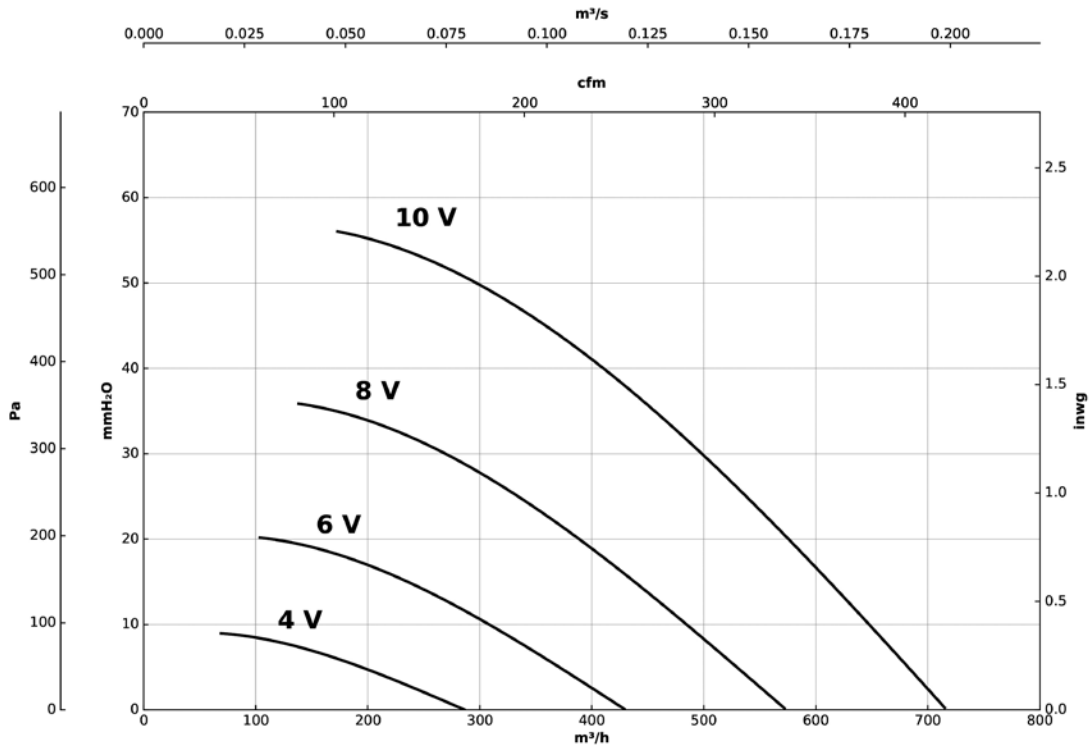

CRF/EW-250-M

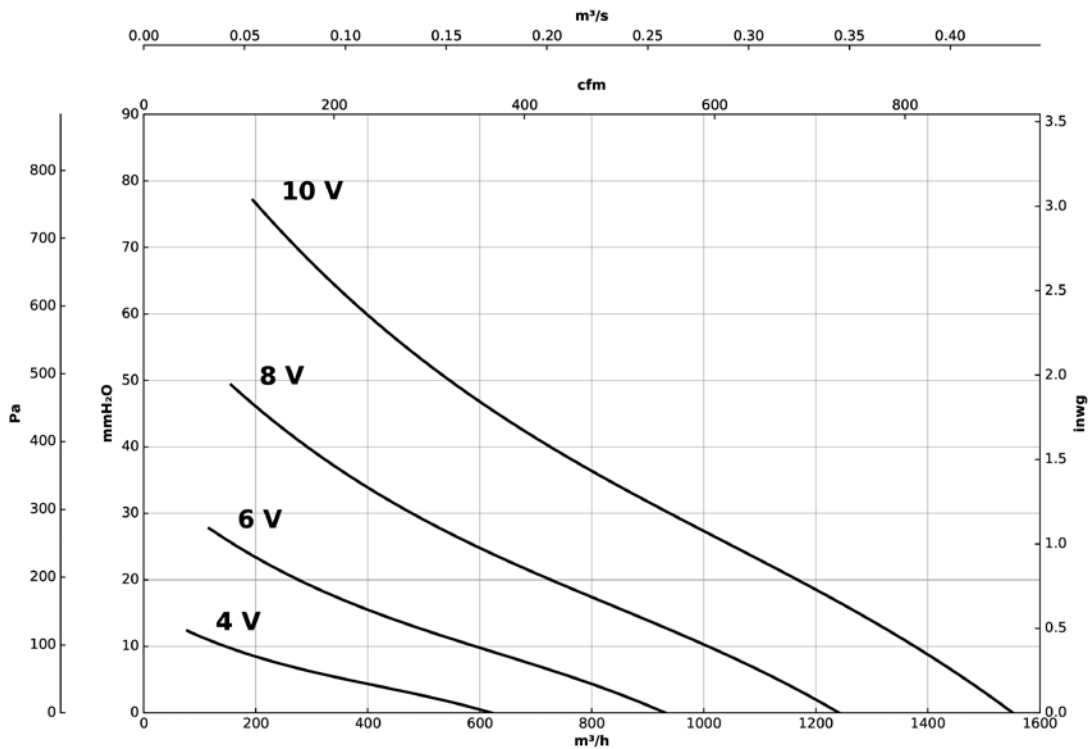

Characteristic curves

Q= Flow rate in m³/h, m³/s and cfm

Pe= Static pressure in mm H₂O, Pa and inwg

CRF/EW-315-M/L

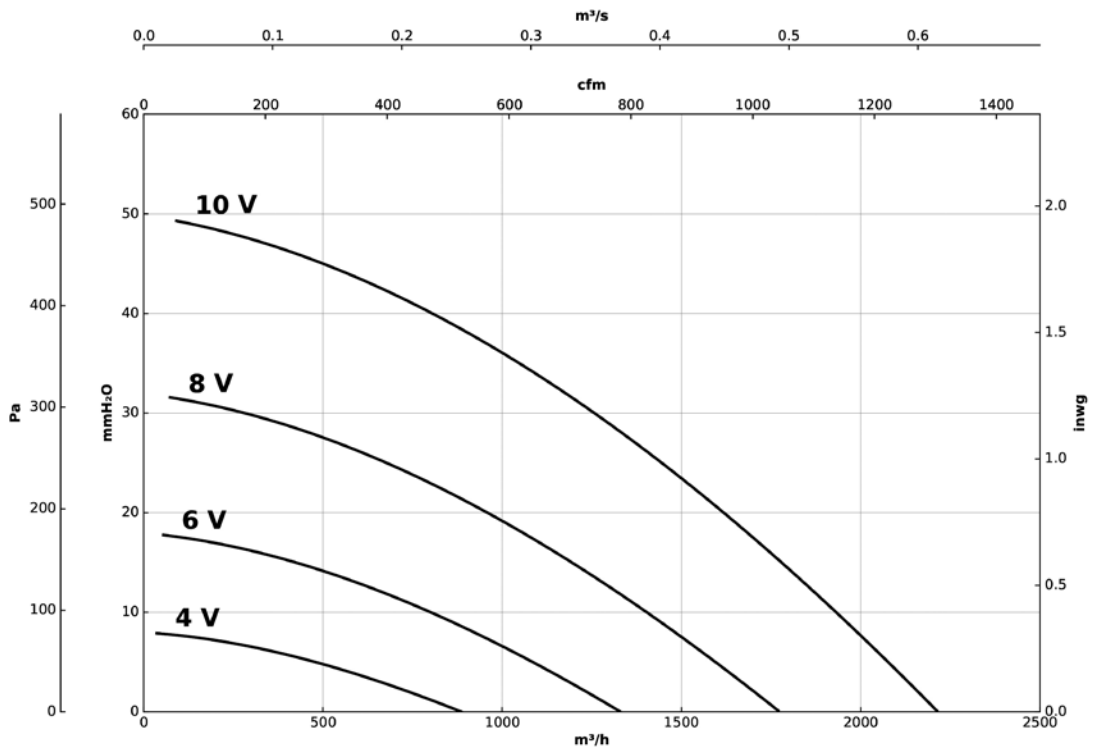

CRF/EW-315-M/H

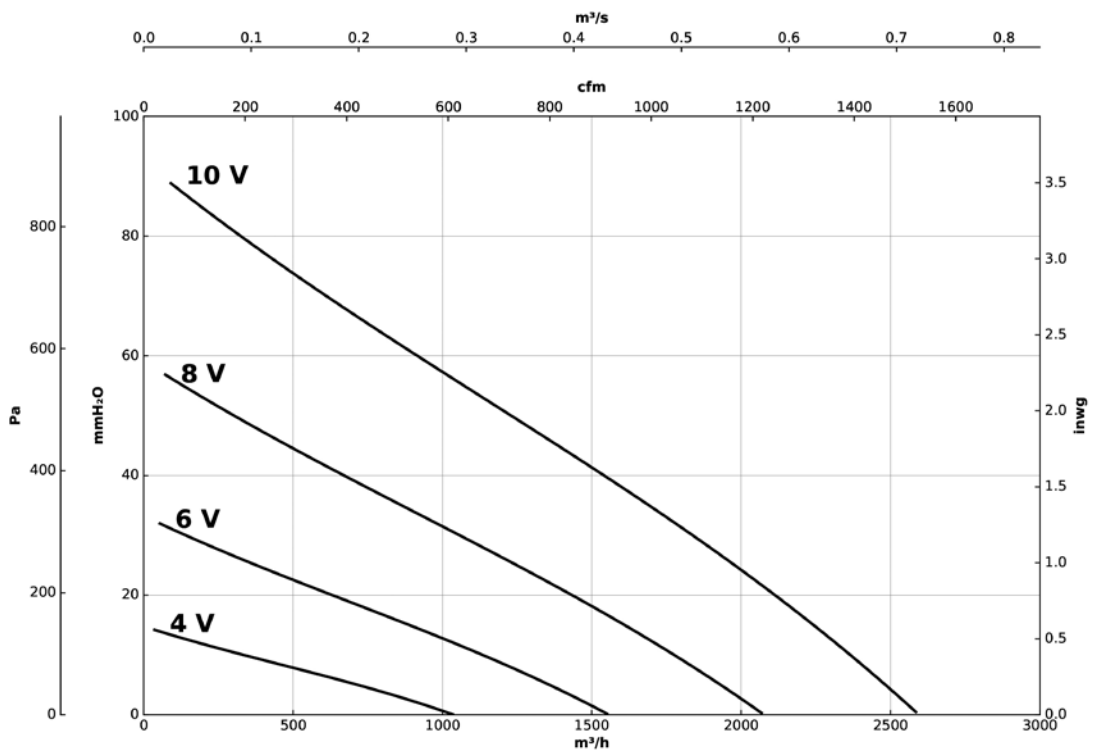

Characteristic curves

Q= Flow rate in m³/h, m³/s and cfm

Pe= Static pressure in mm H₂O, Pa and inwg

CRF/EW-400-M/M

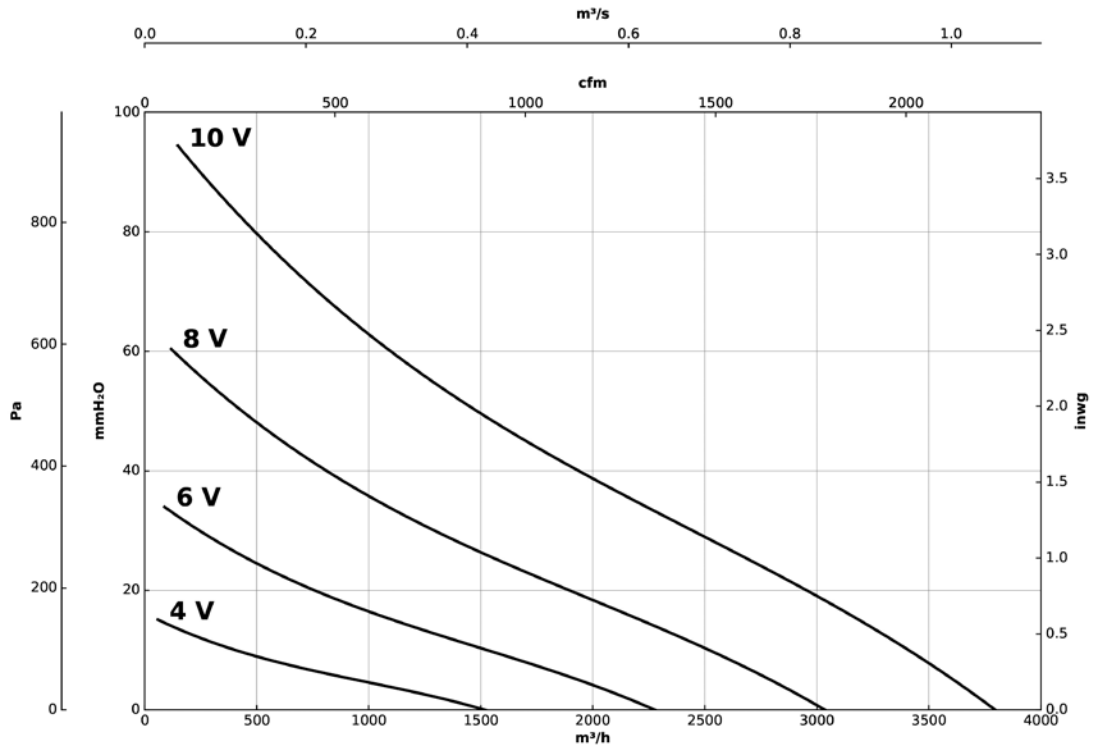

CRF/EW-400-M/H

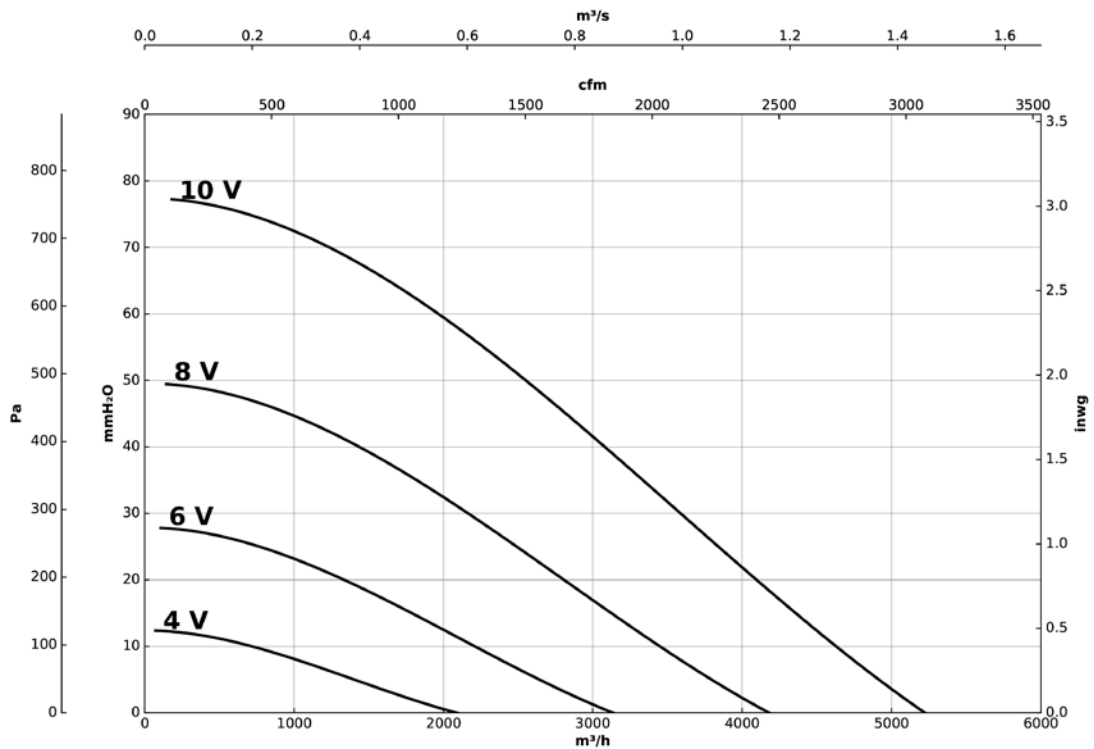

Characteristic curves

Q= Flow rate in m³/h, m³/s and cfm

Pe= Static pressure in mm H₂O, Pa and inwg

CRF/EW-400-T

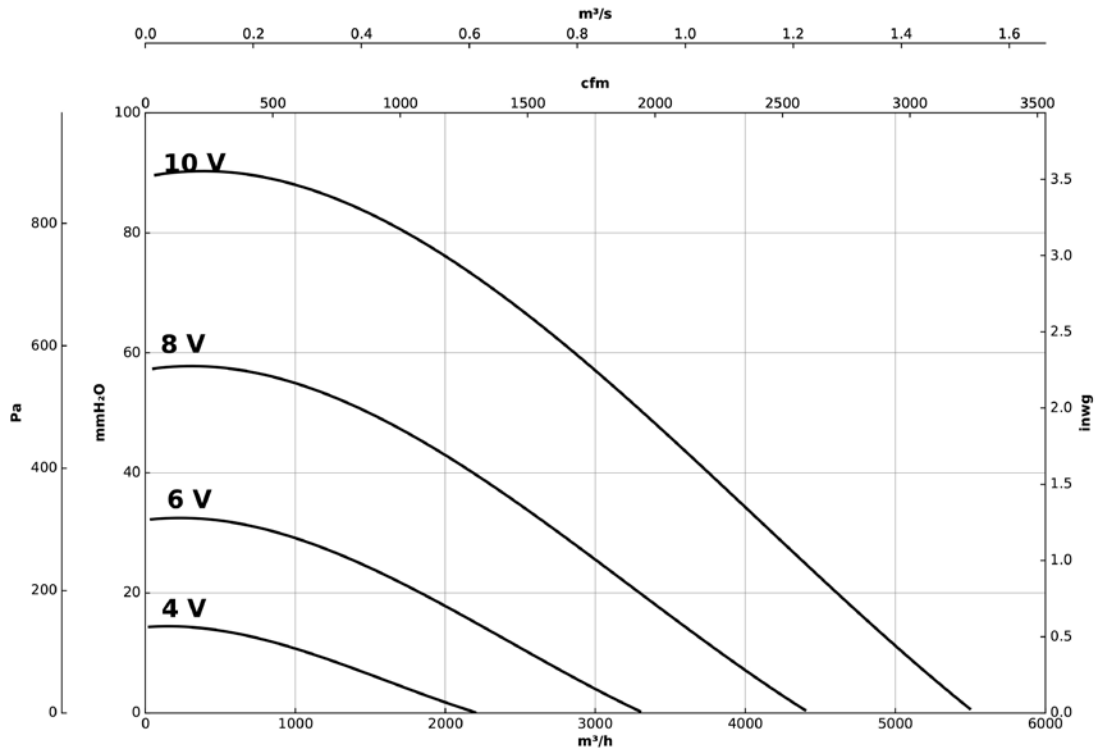

CRF/EW-500-M

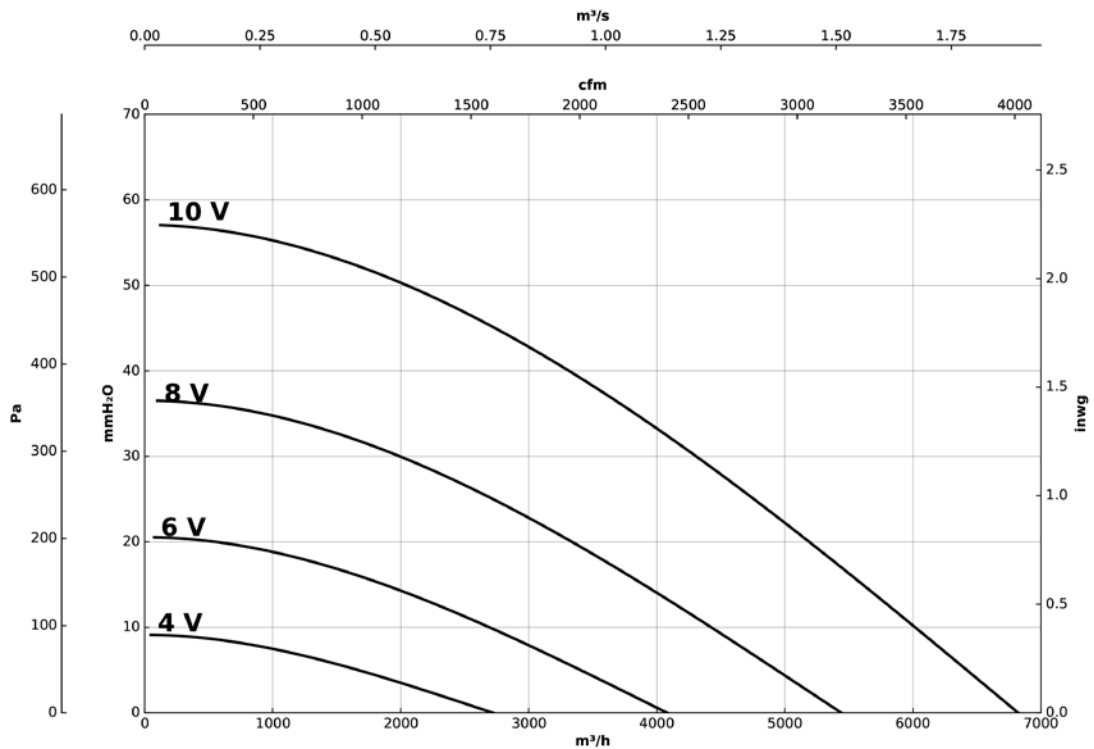

Characteristic curves

Q= Flow rate in m³/h, m³/s and cfm

Pe= Static pressure in mm H₂O, Pa and inwg

